

Agilent 86122B
Multi-Wavelength Meter
User's Guide

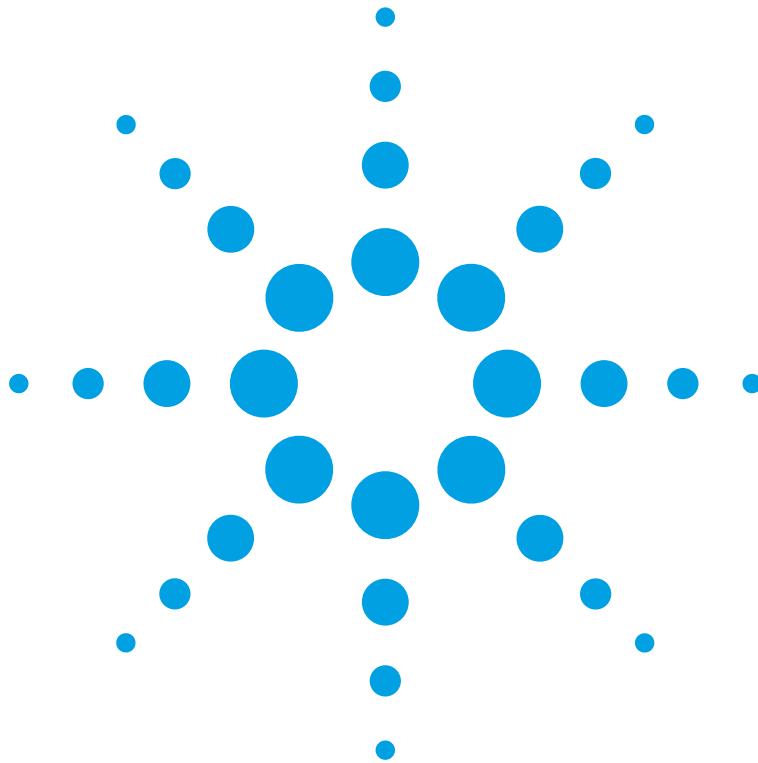

Notices

© Agilent Technologies, Inc. 2002-2011
This document contains proprietary information that is protected by copyright. All rights are reserved.

No part of this document may be reproduced in (including electronic storage and retrieval or translation into a foreign language) without prior agreement and written consent from Agilent Technologies GmbH as governed by United States and international copyright laws.

Agilent Technologies Deutschland GmbH
Herrenberger Str. 130
71034 Böblingen
Germany

Manual Part Number

86122-90B01

Edition

First edition, April 2011

Warranty

This Agilent Technologies instrument product is warranted against defects in material and workmanship for a period of one year from date of shipment. During the warranty period, Agilent will, at its option, either repair or replace products that prove to be defective.

For warranty service or repair, this product must be returned to a service facility designated by Agilent. Buyer shall prepay shipping charges to Agilent and Agilent shall pay shipping charges to return the product to Buyer. However, Buyer shall pay all shipping charges, duties, and taxes for products returned to Agilent from another country.

Agilent warrants that its software and firmware designated by Agilent for use with an instrument will execute its programming instructions when properly installed on that instrument. Agilent does not warrant that the operation of the instrument, software, or firmware will be uninterrupted or error free.

Limitation of Warranty

The foregoing warranty shall not apply to defects resulting from improper or inadequate maintenance by Buyer, Buyer-supplied software or interfacing, unauthorized modification or misuse, operation outside of the environmental specifications for the product, or improper site preparation or maintenance.

No other warranty is expressed or implied. Agilent Technologies specifically disclaims the implied warranties of Merchantability and Fitness for a Particular Purpose.

Exclusive Remedies

The remedies provided herein are Buyer's sole and exclusive remedies. Agilent Technologies shall not be liable for any direct, indirect, special, incidental, or consequential damages whether based on contract, tort, or any other legal theory.

Assistance

Product maintenance agreements and other customer assistance agreements are available for Agilent Technologies products. For any assistance contact your nearest Agilent Technologies Sales and Service Office.

Certification

Agilent Technologies Inc. certifies that this product met its published specifications at the time of shipment from the factory.

Agilent Technologies further certifies that its calibration measurements are traceable to the United States National Institute of Standards and Technology, NIST (formerly the United States National Bureau of Standards, NBS) to the extent allowed by the Institutes's calibration facility, and to the calibration facilities of other International Standards Organization members.

ISO 9001 Certification

Produced to ISO 9001 international quality system standard as part of our objective of continually increasing customer satisfaction through improved process control.

Safety Notices

CAUTION

A CAUTION notice denotes a hazard. It calls attention to an operating procedure, practice, or the like that, if not correctly performed or adhered to, could result in damage to the product or loss of important data. Do not proceed beyond a CAUTION notice until the indicated conditions are fully understood and met.

WARNING

A WARNING notice denotes a hazard. It calls attention to an operating procedure, practice, or the like that, if not correctly performed or adhered to, could result in personal injury or death. Do not proceed beyond a WARNING notice until the indicated conditions are fully understood and met.

Warnings and Notices

WARNING

To avoid the possibility of injury or death, you must observe the following precautions before switching on the instrument.

Insert the power cable plug only into a socket outlet provided with a protective earth contact. Do not negate this protective action by the using an extension cord without a protective conductor.

WARNING

Never look directly into the end of a fiber or a connector, unless you are absolutely certain that there is no signal in the fiber.

Contents

Getting Started	9
General Safety Considerations	10
Setting Up the 86122B	15
Step 1. Inspect the Shipment	16
Step 2. Consider Environmental Specifications	19
Step 3. Configure for Bench Top or Rack Mount Use	21
Step 4. Connect a Keyboard and Mouse (Optional)	23
Step 5. Connect the Line Cord	24
Step 6. Turn On the Line Power	25
Step 7. Calibrate the Touch Screen (Optional)	27
Step 8. Set the Time and Date	29
Step 9. Set the System Standby Mode	30
Step 10. Add a Printer	32
Step 11. Avoid costly repairs	33
Step 12. For More Information	34
Making Measurements	35
Step 1. Consider Measurement Limitations	35
Step 2. Select Basic Measurement Setup Parameters	37
Step 3. Define Laser-Line Peaks	40
Step 4. Make Measurements	42
Step 5. Adjust the Graph to Your Preference	45
Step 6. Save Measurement Results	48
Returning the Instrument for Service	51
Preparing the instrument for shipping	52
Agilent Technologies Service Offices	54
Using the 86122B	55
Introduction	56
Differences Between the 86122B and the 86120C	57
Differences in General Operation	58
Differences in Remote Commands	59
Front and Rear Panel Features	60

Main Screen Layout	62
Graphs and Tables	64
Front Panel Buttons	65
Menus	67
86122B Dialog Box Operation	71
Hard Drive Recovery	72
Cleaning Information	73
<hr/>	
Cleaning Instructions	74
Safety Precautions	74
Why is it important to clean optical devices ?	75
What do I need for proper cleaning?	76
Preserving Connectors	80
Cleaning Instrument Housings	80
Which Cleaning Procedure should I use?	81
How to clean connectors	82
How to clean connector interfaces	84
How to clean bare fiber adapters	85
How to clean instruments with a fixed connector interface ..	86
Additional Cleaning Information	87
Other Cleaning Hints	88
Specifications and Regulatory Information	89
<hr/>	
Definitions of Terms	90
Specifications	92
Compliance with German Noise Requirements	96
Compliance with Canadian EMC Requirements	96
Declaration of Conformity	97

2

Getting Started

General Safety Considerations	10
Setting Up the 86122B	15
Step 1. Inspect the Shipment	16
Step 2. Consider Environmental Specifications	19
Step 3. Configure for Bench Top or Rack Mount Use	21
Step 4. Connect a Keyboard and Mouse (Optional).....	23
Step 5. Connect the Line Cord	24
Step 6. Turn On the Line Power	25
Step 7. Calibrate the Touch Screen (Optional)	27
Step 8. Set the Time and Date	29
Step 9. Set the System Standby Mode	30
Step 10. Add a Printer	32
Step 11. Avoid costly repairs.....	33
Step 12. For More Information	34
Making Measurements	35
Step 1. Consider Measurement Limitations.....	35
Step 2. Select Basic Measurement Setup Parameters.....	37
Step 3. Define Laser-Line Peaks.....	40
Step 4. Make Measurements	42
Step 5. Adjust the Graph to Your Preference	45
Step 6. Save Measurement Results.....	48
Returning the Instrument for Service	51
Agilent Technologies Service Offices	54

General Safety Considerations

This product has been designed and tested in accordance with the standards listed in the Manufacturer's Declaration of Conformity, and has been supplied in a safe condition. The documentation contains information and warnings which must be followed by the user to ensure safe operation and to maintain the product in a safe condition.

Safety Symbols

CAUTION

The *caution* sign denotes a hazard. It calls attention to a procedure which, if not correctly performed or adhered to, could result in damage to or destruction of the product. Do not proceed beyond a caution sign until the indicated conditions are fully understood and met.

WARNING

The *warning* sign denotes a hazard. It calls attention to a procedure which, if not correctly performed or adhered to, could result in injury or loss of life. Do not proceed beyond a warning sign until the indicated conditions are fully understood and met.

Instrument Markings



The instruction manual symbol. The product is marked with this warning symbol when it is necessary for the user to refer to the instructions in the manual.



The laser radiation symbol. This warning symbol is marked on products which have a laser output.



The AC symbol is used to indicate the required nature of the line module input power.



The ON symbols are used to mark the positions of the instrument power line switch.



The OFF symbols are used to mark the positions of the instrument power line switch.



The CE Marking to state compliance within the European Union. This product is in conformity with the relevant European Directives. This text denotes the instrument is an Industrial Scientific and Medical Group 1 Class A product.



The Safety Mark of the Canadian Standards Association CSA.



The C-Tick Conformity Mark of the Australian ACA for EMC compliance.

ISM1-A

This text denotes the instrument is an Industrial Scientific and Medical Group 1 Class A product.



This marking is for China only and states compliance with the Chinese Toxic or Hazardous Substances and Elements requirements.



General Recycling Mark.



This product complies with the WEEE Directive (2002/96/EC) marketing requirements. The affixed label indicates that you must not discard this electrical/electronic product in domestic household waste.

Product category: With reference to the equipment types in the WEEE Directive Annexure I, this product is classed as a "Monitoring and Control instrumentation" product.

Do not dispose in domestic household waste.

To return unwanted products, contact your local Agilent office, or see

www.agilent.com/environment/product/ for more information.

WARNING

If this product is not used as specified, the protection provided by the equipment could be impaired. This product must be used in a normal condition (in which all means for protection are intact) only.

WARNING

No operator serviceable parts inside. Refer servicing to qualified service personnel. To prevent electrical shock do not remove covers.

WARNING

This is a Safety Class 1 Product (provided with protective earth). The mains plug shall only be inserted in a socket outlet provided with a protective earth contact. Any interruption of the protective conductor inside or outside of the instrument is likely to make the instrument dangerous. Intentional interruption is prohibited.

WARNING

To prevent electrical shock, disconnect the instrument from mains before cleaning. Use a dry cloth or one slightly dampened with water to clean the external case parts. Do not attempt to clean internally.

CAUTION

This product complies with Overvoltage Category II and Pollution Degree 2.

CAUTION

Always use the three-prong AC power cord supplied with this instrument. Failure to ensure adequate earth grounding by not using this cord may cause instrument damage.

CAUTION

This instrument has autoranging line voltage input. Be sure the supply voltage is within the specified range.

CAUTION

Use of controls or adjustment or performance of procedures other than those specified herein may result in hazardous radiation exposure.

CAUTION

The 86122B Multi-Wavelength Meter uses a specially designed Windows application program (Windows® is a U.S. registered trademark of Microsoft Corp.) All 86122B Multi-Wavelength Meter functionality is directly available from within the 86122B Multi-Wavelength Meter application. Windows configuration changes made outside of the 86122B Multi-Wavelength Meter application may not work correctly and could cause the instrument to become inoperable. Do not try to access or make changes to the Windows Operating system. Repairs caused by the improper use of the 86122B Multi-Wavelength Meter will not be covered under warranty.

CAUTION

VENTILATION REQUIREMENTS: When installing the product in a cabinet, the convection into and out of the product must not be restricted. The ambient temperature (outside the cabinet) must be less than the maximum operating temperature of the product by 4° C for every 100 watts dissipated in the cabinet. If the total power dissipated in the cabinet is greater than 800 watts, then forced convection must be used.

CAUTION

Install the instrument so that the detachable power cord is readily identifiable and is easily reached by the operator. The detachable power cord is the instrument disconnecting device. It disconnects the mains circuit from the mains supply before other parts of the instrument. The front panel switch is only a standby switch and is not a LINE switch. Alternatively, an externally installed switch or circuit breaker (which is readily identifiable and is easily reached by the operator) may be used as a disconnecting device.

Laser Safety Considerations

NOTE

Refer to the *Tunable Laser Modules User's Guide* for complete laser safety information.

WARNING

Do NOT, under any circumstances, look into the optical output or any fiber/device attached to the TLS output while the laser is in operation.

This system should be serviced only by authorized personnel.

Do not enable the laser unless fiber or an equivalent device is attached to the optical output connector.

CAUTION

Use of controls or adjustments or performance of procedures other than those specified herein can result in hazardous radiation exposure.

Setting Up the 86122B

This section describes the steps required to properly set up your 86122B

Step 1. Inspect the Shipment

1 Use proper lifting techniques to remove the items from the shipping container.

NOTE

Keep the shipping container and cushioning material until you have inspected the contents of the shipment for completeness and have inspected the instrument.

2 Inspect the shipment.

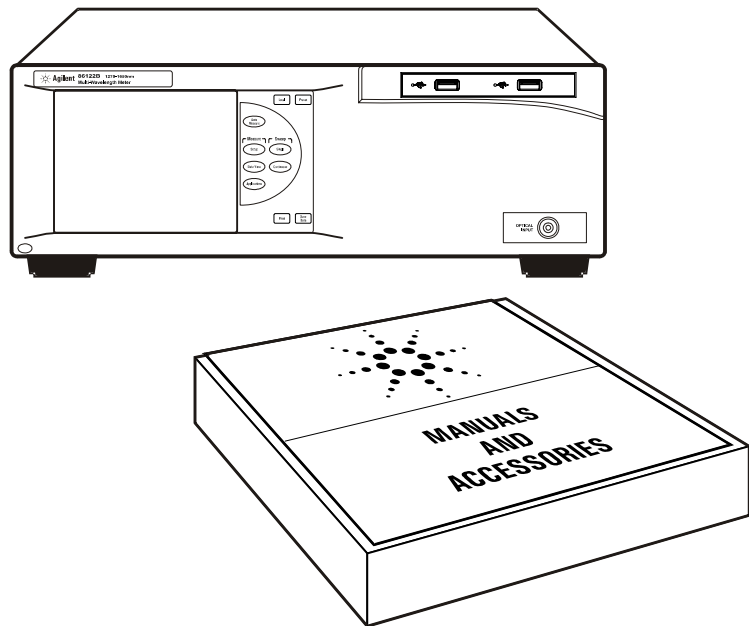

- Inspect the shipping container for damage.
- Inspect the instrument.
- Verify that you received the options and accessories you ordered.

If anything is missing or defective, contact your nearest Agilent Technologies Service Office. [Refer to “Agilent Technologies Service Offices” on page 54.](#) If the shipment was damaged, contact the carrier, then contact the nearest Agilent Sales Office. Keep the shipping materials for the carrier’s inspection. The Agilent Sales Office will arrange for repair or replacement at Agilent’s option without waiting for claim settlement.

Options and Accessories

The following table lists the accessories that may be on the 86122B shipping list. The information on your actual shipping list is more accurate and should supersede the information in this table.

Table 1 Accessories Included

Accessories	Part Number
Stylus	1150-7997
Getting Started	86122-90A01
Power Cord	depends on country
86122B-UK6	Commercial Calibration Certificate with Test Data

The following table lists the available product options. Make sure that you received all of the options that you ordered.

Table 2 Instrument Options

Option	Description
Optical Connectors	
86122B-021	Straight (non-angled) Contact Interface-PC (default)
86122B-022	Angled Contact Interface-APC
Accessories	
86122A-1CM	Rack Mount Kit without Handles
86122A-1CN	Rack Handle Kit
86122A-1CP	Mount Kit plus Handles

Table 3 Fiber-Optic Adapters

Agilent Part Number	Description
81000FI	Connector Interface FC/PC/SPC
81000HI	Connector Interface E-2000(PHYSICAL CONTACT)
81000KI	Connector Interface SC
81000LI	Connector Interface LC
81000NI	Connector Interface FC/APC, narrow key
81000SI	Connector Interface DIN 47256/4108
81000VI	Connector Interface ST
81000MI	Connector Interface MU

Step 2. Consider Environmental Specifications

Review the following specifications to ensure that your operating or storage environment is suitable for the instrument

Temperature	
Operating	+15°C to +35°C
Non-operating	-40°C to +70°C
Humidity	
Operating	< 75% relative humidity at +35°C, 5 day soak
Non-operating	Noncondensing 95% relative humidity at +40°C for 5 day cycle
Altitude	
Operating	Up to 2000m (6600 ft)

NOTE

Humidity is type tested. Type tested means tested, but not warranted, for continuous operation.

Shock 120 g, half sine, 2 ms pulse

NOTE

Shock is type tested.

Vibration Random, 2 g rms, 5-500 Hz, 10 minutes per axis
Sine, 0.5 g (0 to peak), 5 to 500 Hz, 1 octave per minute

NOTE

Vibration is type tested.

Power Requirements	
Voltage	100-240 V~
Frequency	50-60 Hz
Maximum Power	240 W
Weight	14.5 kg (32 lb)
Dimensions	
Height	138 mm (5.2 in)
Width	425 mm (16.7 in)
Depth	520 mm (20.5 in)

Step 3. Configure for Bench Top or Rack Mount Use

The 86122B is shipped ready for bench-top use. To configure the instrument for rack mount use, follow the steps below.

NOTE

You must have a rack mount kit to continue with this procedure. Refer to [“Accessories” on page 17](#).

1 Ensure that the rack mount kit is complete.

If any items are damaged or missing from the kit, contact the nearest Agilent Technologies sales or service office to order a replacement kit. Items within the kit are not individually available.

Table 4

Qty	Description
2	Rack Mount Flange
6	Screws
4	Dress screws
2	Front Handle Assembly (86122A-1CP only)

2 Remove the side trim strips.

3 Attach rack mount flange with three screws per side.

WARNING

Use only the screws the come with the rack mount kit. Longer screws may damage the instrument, and shorter screws may be unsafe.

4 Remove feet before rack mounting

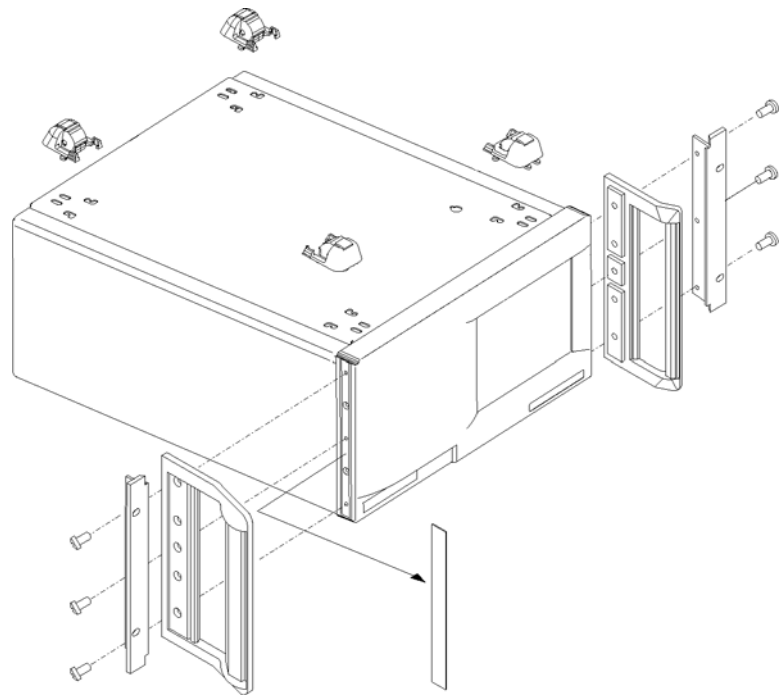

Front Handle Assembly are included with Option 86122A-1CP only.

Step 4. Connect a Keyboard and Mouse (Optional)

You may connect a standard PC-compatible mouse and keyboard to the instrument. Refer to the figure below for PS/2 connections. You can also use the USB port for a USB keyboard and mouse. You can also connect USB mouse and keyboard with the USB port in the front panel of the instrument.

NOTE

A keyboard and mouse are not supplied with the 86122B.

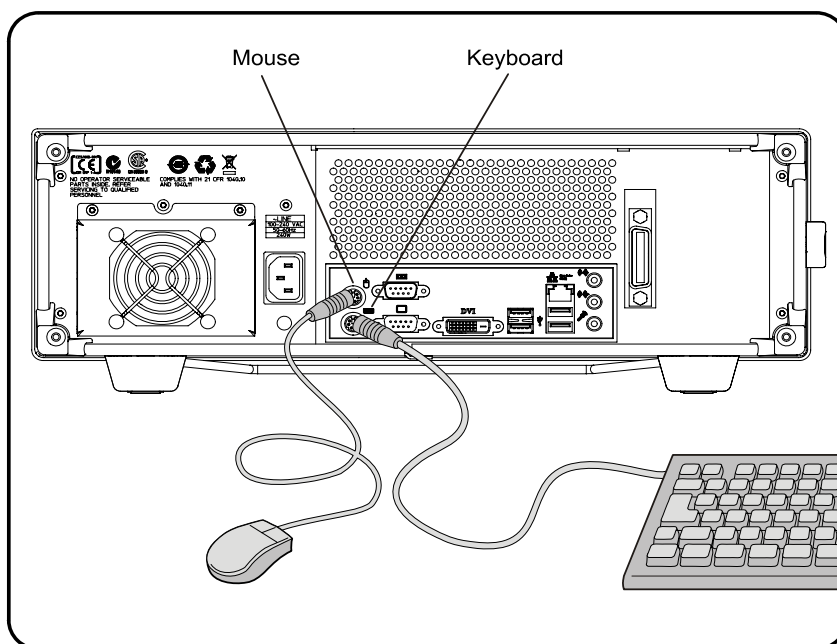
**NOTE**

Do *not* stack other objects on the keyboard; this will cause self-test failures at power-on.

Step 5. Connect the Line Cord

Connect the line cord as shown in the figure below.

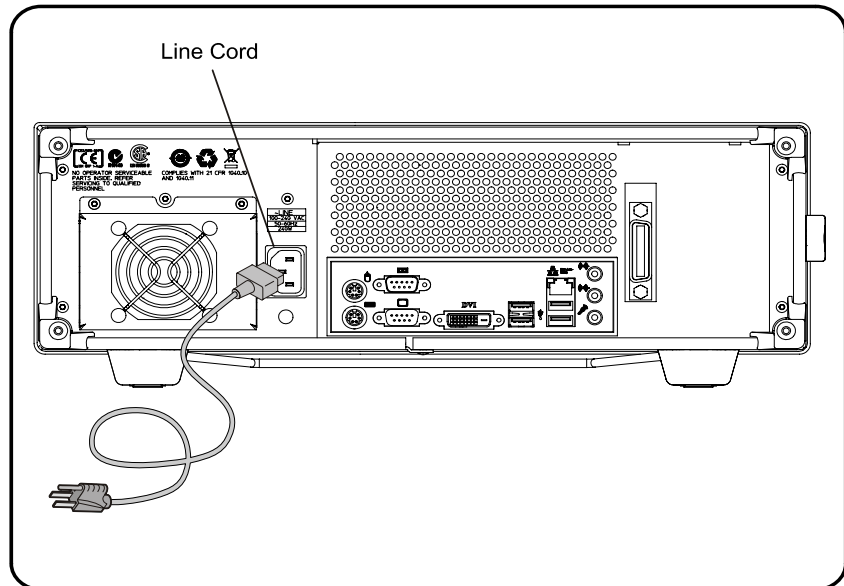

The product can operate from any single-phase AC power source supplying 100 – 240 V in the frequency range from 50 – 60 Hz. The maximum power consumption is 240 W. The power supply automatically adapts to the applied AC power (Auto Selection) and monitors the AC power range. The mains supply voltage fluctuation shall not exceed 10% of the specified supply voltage.

CAUTION

The product must be operated from a power source providing Line, grounded Neutral and Protective Earth (PE) connections. The instrument is not intended for operation from two phases of a multi-phase ac system or across the legs of a single-phase, three-wire AC power system. Crest factor (ratio of peak voltage to rms.) should be typically within the range of 1.3 to 1.6 at 10% of the nominal rms. mains voltage.

Step 6. Turn On the Line Power

Press the power switch at the lower left-hand corner of the front panel. After stabilisation of the internal reference laser the instrument will show application screen and is ready to use.

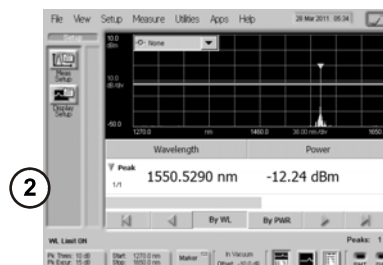
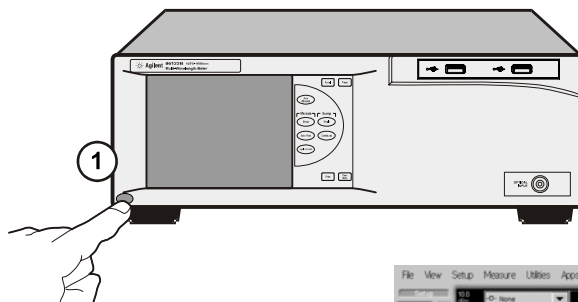

Interacting With the Display

The 86122B is equipped with a touch screen display. You can explore the instrument's functions and settings by touching elements on the display (such as menus, buttons, and other controls) with your finger or the supplied stylus.

You can also operate the instrument by using an optional mouse. For simplicity, the term "click" is used throughout this book to represent *clicking or touching* an element on the display. When you see the term "click," please remember that you can always touch with your finger or stylus instead.

NOTE

The display will always function as a touch screen, even when a mouse and keyboard are connected.

CAUTION

Avoid touching the screen with a sharp object, as this could result in damage to the display. Use your finger or the supplied stylus.

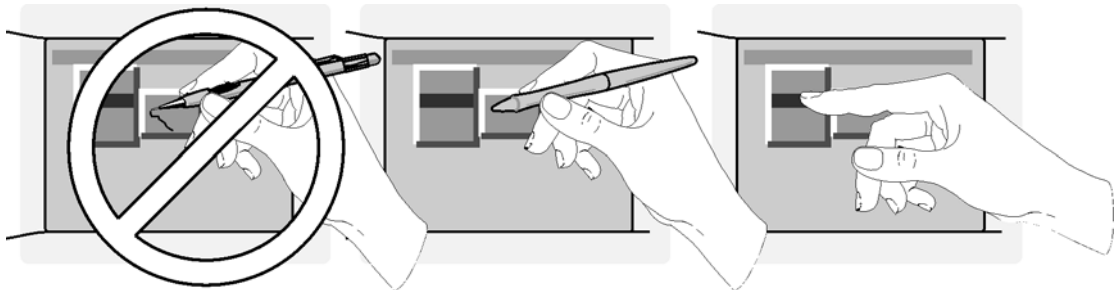

Step 7. Calibrate the Touch Screen (Optional)

NOTE

The touch screen calibration rarely needs to be performed.

Touch screen calibration ensures that the touch screen is both accurately aligned and orientated with the display. Therefore, when you touch an element on the display screen, the instrument can detect the task you want to perform.

- 1 On the Utility menu, click Touch Screen Calibration. The touch screen calibration utility opens.

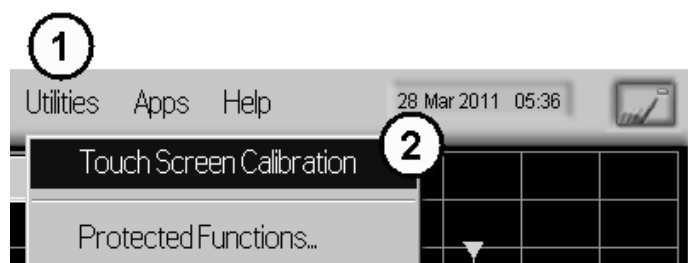

- 2 Touch the center of the X with your finger or a stylus. Several X will appear on different positions of the display screen. Touch them precisely as the first one. When the display is calibrated, the touch screen configuration utility closes.

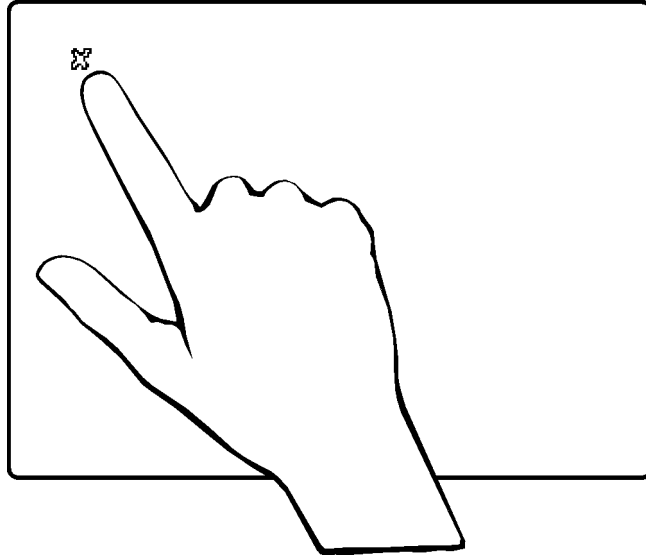

The calibration will time out within 10 seconds if you do not touch the center of the X. You can also press Esc on an optional keyboard to exit the touch screen calibration.

NOTE

If you miss the center of the X by a significant amount, the instrument will display an error message and revert back to the previous calibration. This will prevent the touch screen from being rendered useless due to a poor calibration.

In case a failed touch screen calibration leads to a non-working condition, you can restart the touch screen calibration by using a USB mouse.

Step 8. Set the Time and Date

- 1 Click the current time and date shown near the top of the display. The Set Time and Date dialog box opens.
- 2 Enter the current time and date in one of the following ways:
 - Click the time and date text boxes, and enter the desired number.
 - Click the up or down arrows next to the time and date text boxes until the desired number is displayed.
- 3 Click **Set Time & Date Now** to apply the changes and close the dialog box.

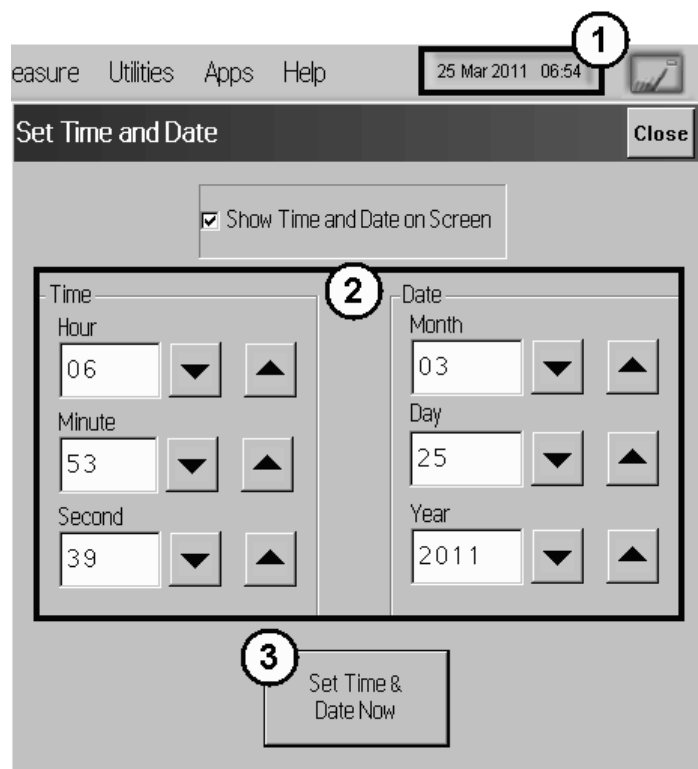

Step 9. Set the System Standby Mode

If the multi-wavelength meter has been inactive for a specified period of time, it will be switched into standby mode. When this happens, two things will occur:

- The LCD display indicates the standby mode.
- If the instrument is in Continuous sweep mode, the motor movement, and any related data collection, will be suspended.

NOTE

The internal reference laser is always on to allow the instrument to immediately make accurate measurements when it is reactivated.

Any subsequent activity, front-panel or remote, will reactivate the instrument and return it to its previous state. Using this feature can help extend the life of your instrument. To extend the life of the reference laser, you should turn off the instrument during long periods of inactivity (e.g. several hours or over night).

To configure standby mode

- 1 On the Setup menu, click Preferences.
- 2 Select a time-out period from the System Standby list. You can choose 15 min., 30 min., 1 hr., 4 hrs., or Never. Selecting **Never** disables this feature.

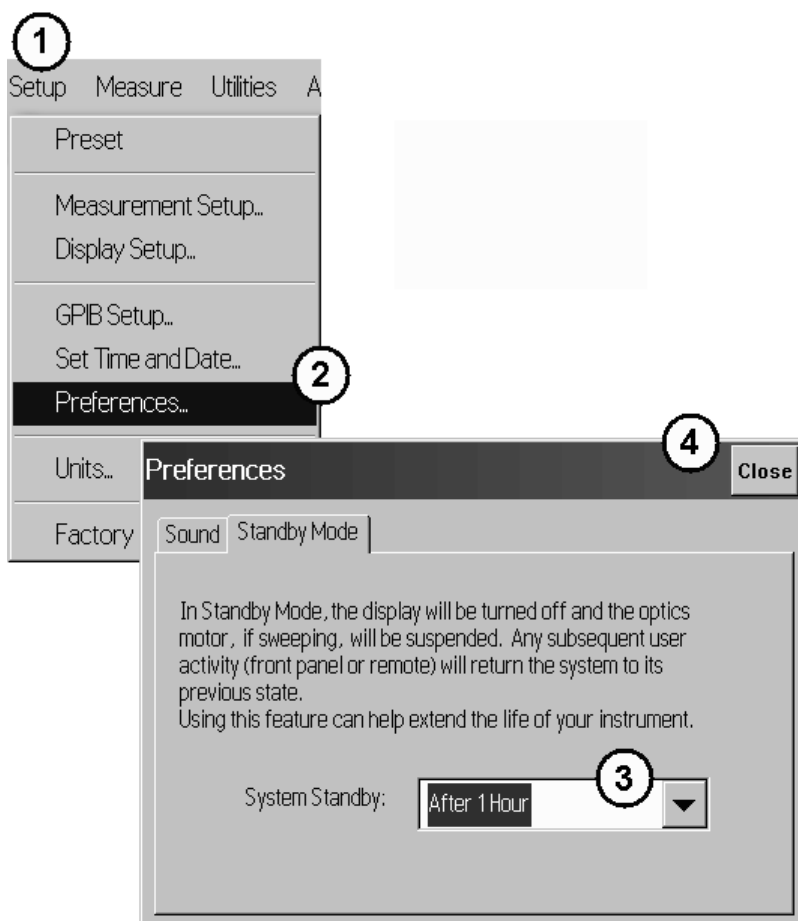

To reactivate the display

- Touch the display screen or a front panel button
- Move the mouse or press a key on the external keyboard (if attached)
- Send a remote command

Step 10. Add a Printer

Use of a printer with the 86122B is optional. Follow the steps of your printer's documentation.

NOTE

The 86122B only supports USB and LAN printers (no parallel printer port).

- 1 Exit the 86122B software.
 - a On the Utilities menu, click Protected Functions.
 - b Enter the protected functions password "exit to windows" and click Activate.

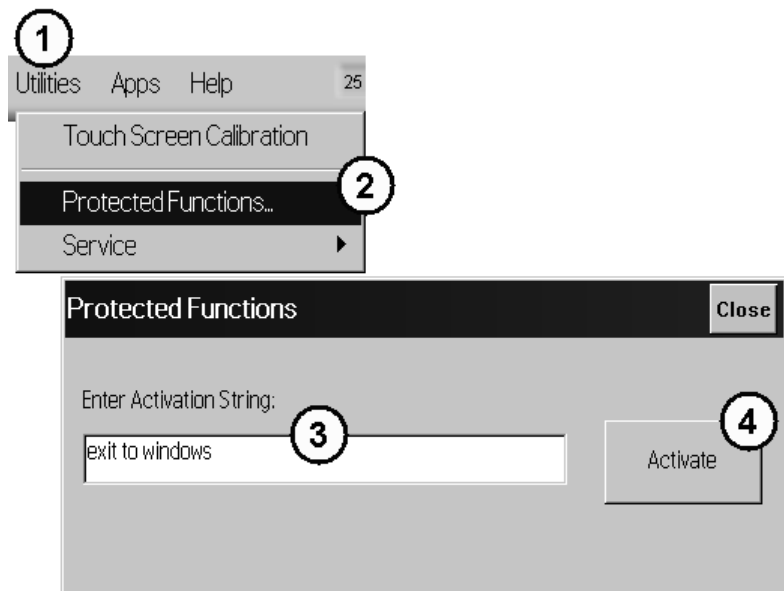

- 2 Follow the installation instructions of your printer.
- 3 To return to the 86122B software, cycle the instrument power, or click *Start*, point to *Programs*, and then click *86122B*.

CAUTION

Installation of programs other than drivers necessary for your printer is not recommended or supported. Installation of additional software could render the 86122B software inoperable.

Step 11. Avoid costly repairs

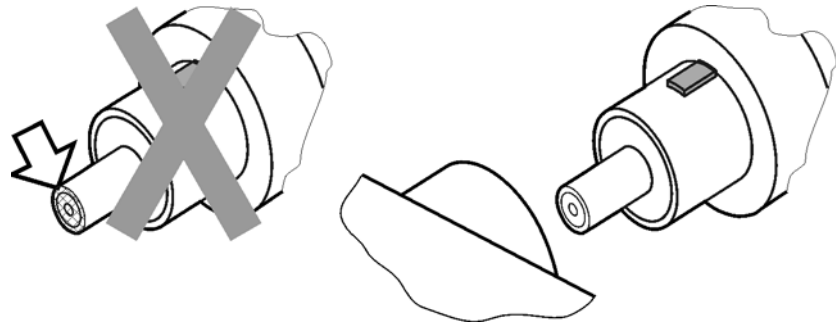

CAUTION

Optical channel fiber-optic connectors are easily damaged when connected to dirty or damaged cables and accessories. When you use improper cleaning and handling techniques, you risk expensive instrument repairs, damaged cables, and compromised measurements. Before you connect any fiber-optic cable to the instrument, refer to [“Cleaning Instructions” on page 74](#).

Step 12. For More Information

There are several ways to learn more about your 86122B.

- Continue reading this book. Chapter 3, “Using the 86122B” on page 55, will help you get started using this instrument.
- Refer to the Help. The Help opens the user’s and programmer’s guide in PDF format.
- Visit our website at <http://www.agilent.com>. Use the keyword “86122B” in your search.

Search: in

Making Measurements

This chapter explains the steps required to make a measurement.

Step 1. Consider Measurement Limitations

Before connecting a signal and making a measurement, please consider the following measurement limitations:

NOTE

The front-panel OPTICAL INPUT connector uses a single-mode input fiber.

CAUTION

+10 dBm is the maximum total displayed input power. Do not exceed +18 dBm source power. The Agilent 86122B's input circuitry can be damaged when total input power exceeds this level.

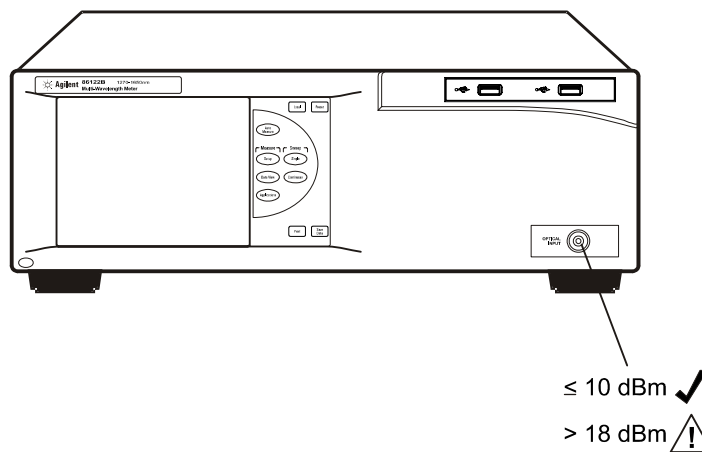

CAUTION

Optical channel fiber-optic connectors are easily damaged when connected to dirty or damaged cables and accessories. When you use improper cleaning and handling techniques, you risk expensive instrument repairs, damaged cables, and compromised measurements. Before you connect any fiber-optic cable to the Agilent Variable Optical Attenuator modules and Agilent Variable Optical Attenuator modules with Power Control, refer to [“Cleaning Instructions”](#) on page 74.

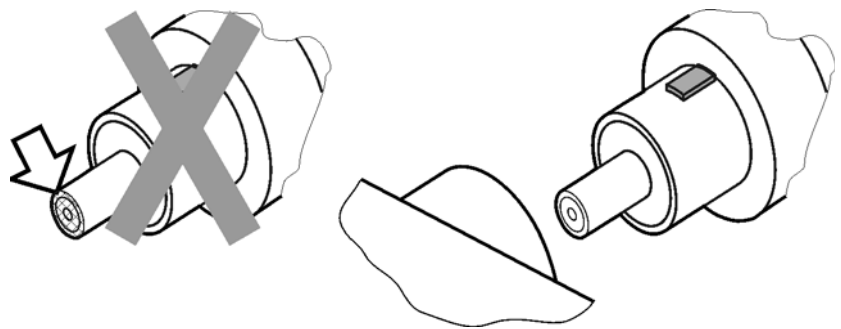
**WARNING**

Always remove both ends of fiber-optic cables from any instrument, system, or device before visually inspecting the fiber ends. Disable all optical sources before disconnecting fiber-optic cables. Failure to do so may result in permanent injury to your eyes.

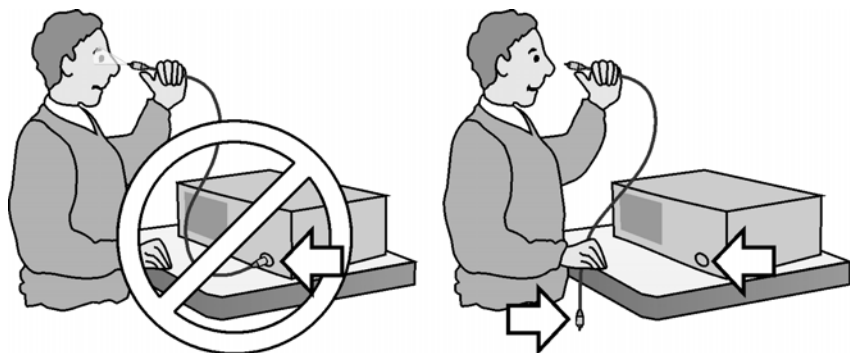

- If the measured amplitudes are low, clean the front-panel OPTICAL INPUT connector.
- 1270 - 1650 nm is the maximum input wavelength range
- Laser line widths are assumed to be less than 2.5 GHz

Step 2. Select Basic Measurement Setup Parameters

Basic measurement setup parameters that you should choose before making a measurement are medium, device type, units, and sweep mode.

Select the Medium

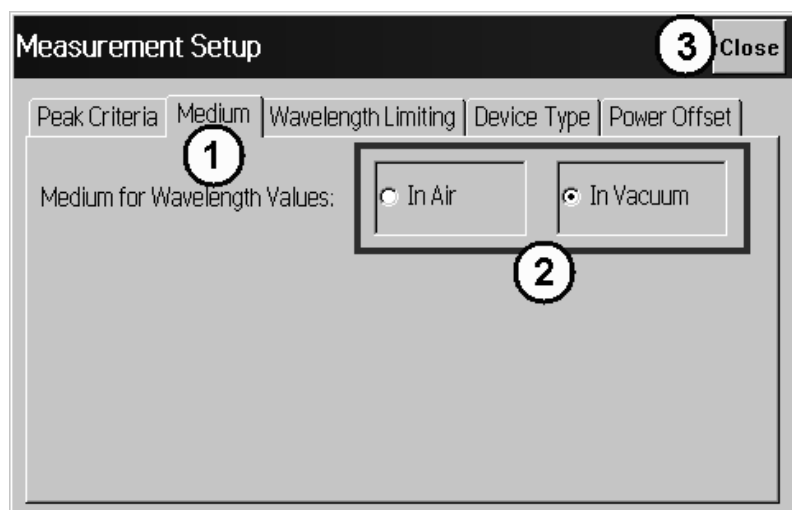

The 86122B can display wavelength values in a vacuum, or in standard air.

- 1 Press  and click .
- 2 Click the Medium tab, and select In Air or In Vacuum.
- 3 Click Close.



Select the Units

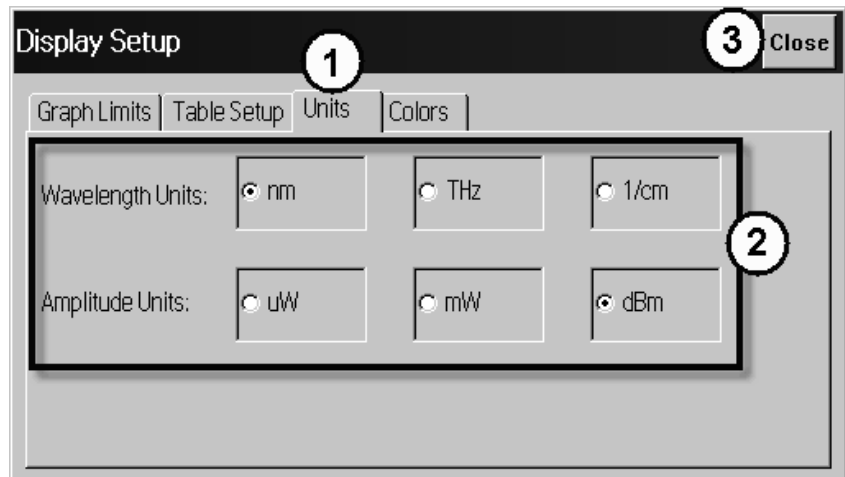

The 86122B can display wavelength and amplitude values in several types of measurement units.

- 1 Press  and click .
- 2 Click the Units tab, and select the wavelength and amplitude units.
- 3 Click Close.





Select the Device Type

You can optimize (or match) the measurement technique of the 86122B to the type of device you are measuring – narrowband or broadband. Narrowband devices include DFB lasers and modes of Fabry-Perot lasers. Broadband devices include LEDs, optical filters, and chirped lasers.

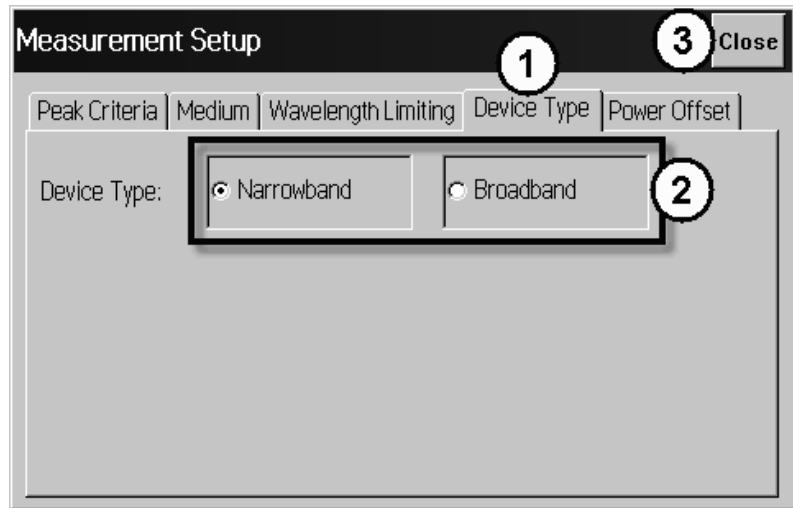
- 1 Press  and click .
- 2 Click the Device Type tab, and select Narrowband or Broadband.
- 3 Click Close.



Select the Sweep Mode

- Press  to initiate one measurement sweep. This is useful if you want the data to remain static for saving results or printing.
- Press  to continuously measure the input spectrum. In this mode, a measurement sweep occurs approximately every 0.5 seconds. This is useful if you want the data to be continuously updated.

You can also set up data logging to perform measurement sweeps at any desired interval. The green SWP indicator in the lower right-hand corner is lit when a measurement is being acquired.

Step 3. Define Laser-Line Peaks

Peak criteria settings and wavelength limiting allow you to define how laser line peaks are measured.

How Laser-Line Peaks are Defined

A laser line will only be measured as a peak if the amplitude is greater than the peak threshold limit and the rise-and-fall (excursion) is greater than or equal to the peak excursion. In addition, peaks are only measured within the wavelength limits that you specify.

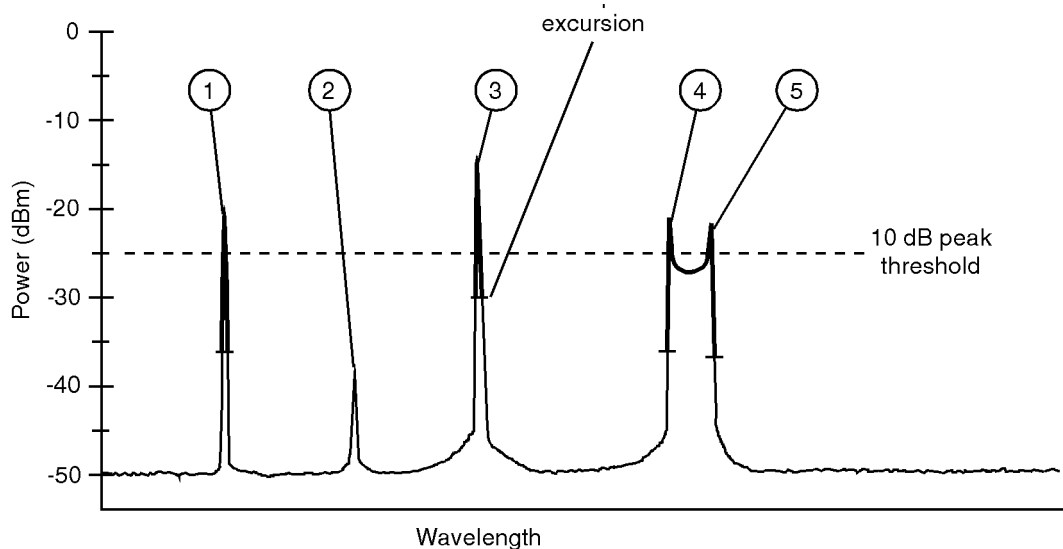

- In this figure, only three laser lines are identified as peaks: responses 1, 3, and 4.
- Response 2 is not identified as a peak because it is below the peak threshold.
- Responses 4 and 5 are identified as one peak laser line. This is because the minimum point between 4 and 5 does not drop to the peak excursion limit.



Use Peak Criteria to Define Peaks

- 1 Click .
- 2 Click the Peak Criteria tab.
- 3 Select Relative or Absolute threshold type.
- 4 Click the Threshold Value box and enter the threshold value.

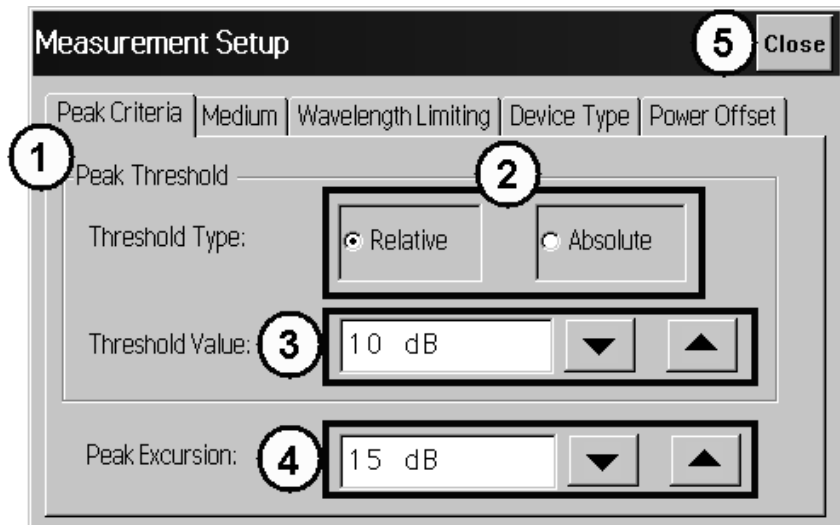
- 5 Click the Peak Excursion box and enter the excursion value.
- 6 Click Close.



Use Wavelength Limiting to Define Peaks

- 1 Press  and click .
- 2 Click the Wavelength Limiting tab.
- 3 Select On
- 4 Click the Limit Start Wavelength box and enter the start wavelength value.
- 5 Click the Limit Stop Wavelength box and enter the stop wavelength value.
- 6 Click Close.

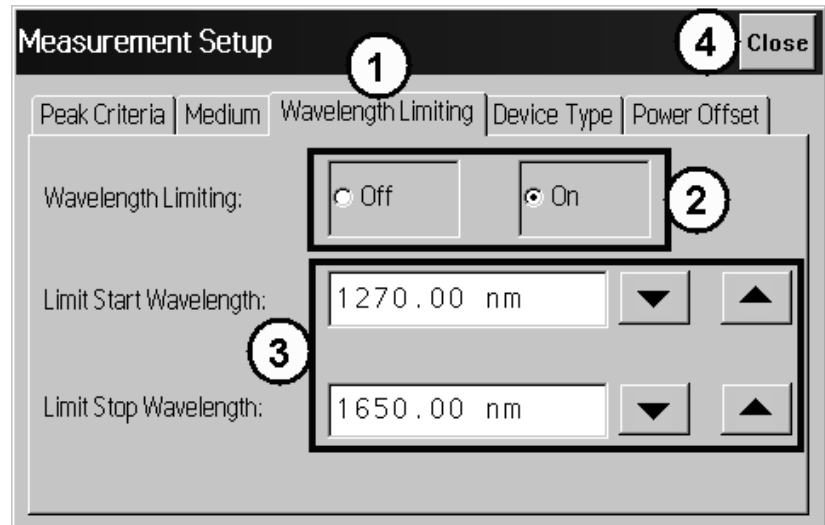

Step 4. Make Measurements

The 86122B can make a wide variety of wavelength and power measurements.

Peak Wavelength and Power

Press  and click .

Multiple Laser Lines



Press  and click .

Average Wavelength and Total Power

Press  and click .



Laser Channel Separation

It is often important to measure the wavelength and power separation between multiple laser lines. This is especially true in wavelength-division-multiplexed (WDM) systems where channel spacing must be adhered to. The Agilent 86122B can display the wavelength and amplitude of any laser line relative to another.

- 1 Press  and click  .
- 2 Select a channel as the reference by clicking in the “Ref” column of the desired row.
- 3 To determine channel spacing from the reference, simply read the relative wavelength values in the “Delta WL” column.

Laser Channel Flatness

You can use relative power measurements to measure flatness (pre-emphasis) in a WDM system. Simply select one carrier as the reference and measure the remaining carriers relative to the reference level. The power differences represent the system flatness.

- 1 Press  and click  .
- 2 Select the channel with the largest amplitude as the reference by clicking in the “Ref” column of that peak’s row.
- 3 To determine channel flatness from the reference, simply read the relative power values in the “Delta Pwr” column.

Laser Channel Separation/Flatness

You can also measure channel separation and flatness at the same time.

- Press  and click  .

Laser Drift

Laser drift can be easily measured by using the drift application.

- Press  and click  .

Signal-to-Noise Ratio

Signal-to-noise ratio can be easily measured by using the OSNR application.

Press  and click .

Fabry-Perot Lasers

Fabry-Perot lasers can be easily measured by using the Fabry-Perot Laser application.

Press  and click .

Power Greater than 10 dBm

The maximum total input power that can be measured is 10 dBm. However, with the addition of an external attenuator, more power can be applied. This may be necessary at the transmit end of a wavelength-division-multiplexed system where large signal levels are present. By entering a power offset equal to the amount of attenuation at the instrument's input, accurate amplitude measurements are shown on the display.

- 1 Connect an optical attenuator between the front-panel OPTICAL INPUT connector and the fiber-optic cable from your device. The attenuator must reduce the total input power to the Agilent 86122B so that it is below +10 dBm.

2 Press  and click .

- 3 Click the Power Offset tab.

- 4 Click the Power Offset box, and enter a power offset value.

- 5 Click Close.

Power offset values are added to the display power readings. For example, if you placed a 10-dB attenuator on the front-panel connector, you should enter a power offset value of +10 dB. Negative values can also be entered if you connect an amplifier instead of an attenuator.

Step 5. Adjust the Graph to Your Preference

After you have set up your measurement, you may wish to adjust the graph x-axis or move markers.

Adjust the X-Axis

You can adjust the x-axis in any of the following ways:

- Click  and enter graph limits as start/stop or center/span.

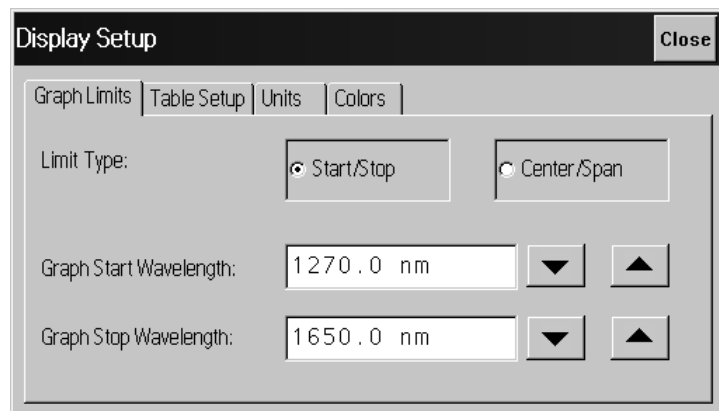

- Select an x-axis control from the Graph Control list. Click anywhere on the graph and drag to the left or right.



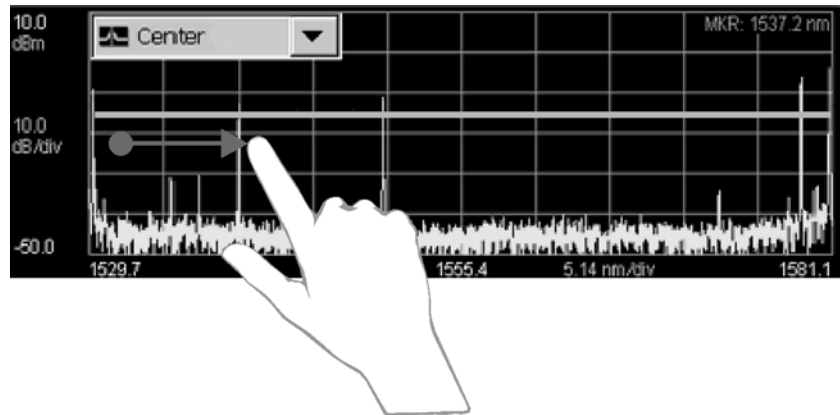

Move the Peak Marker

You can move the peak marker in any of the following ways:

- Click any cell in the “Peak” column of the table. The peak marker will move to the corresponding peak wavelength in the graph.

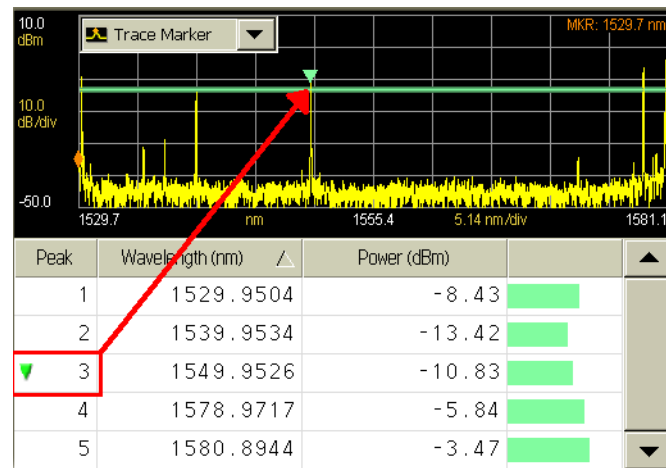

- If ClickZoom is enabled, click any cell in the “Wavelength” column of the table. The peak marker will move to the corresponding peak wavelength in the graph, and the graph will zoom in to that peak. To zoom out, click the “Wavelength” cell again.

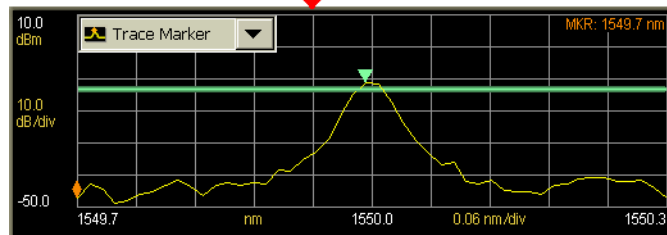
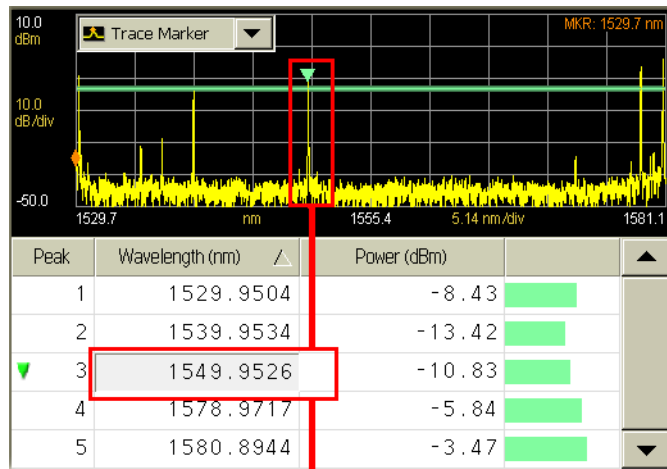

- Select Peak Marker from the Graph Control list. Click close to a peak on the graph.
- Select Peak Marker from the Graph Control list. Click anywhere on the graph and drag to the left or right.

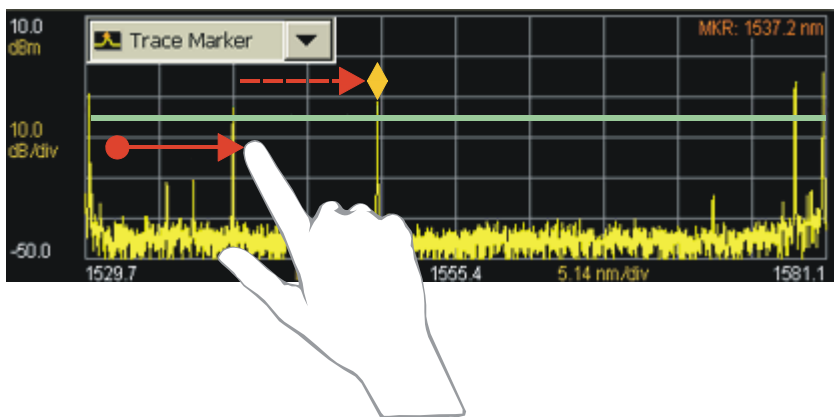

- Select Peak Marker from the Graph Control list. Click close to a peak on the graph.
- Select Peak Marker from the Graph Control list. Click anywhere on the graph and drag to the left or right.

Move the Trace Marker

You can move the trace marker in any of the following ways:

- Select Trace Marker from the Graph Control list. Click any point on the graph.
- Select Trace Marker from the Graph Control list. Click anywhere on the graph and drag to the left or right.

Step 6. Save Measurement Results

After you have set up your measurement and the graphical display, you may wish to save measurement results.

Save Data

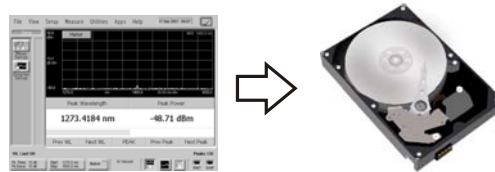

Press  to open the Save Meas Data dialog box. Select a file name and click **Save**.

Print Data

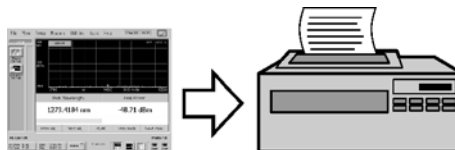

Press  to open the Print Setup dialog box. Select the Default Printer and Printout Type, and click Print.

Save Screen Image

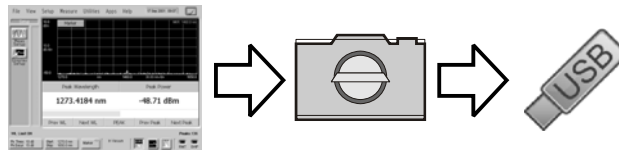

On the File menu, point to Save, and then click Save Screen Image. Select a file name and click Save.

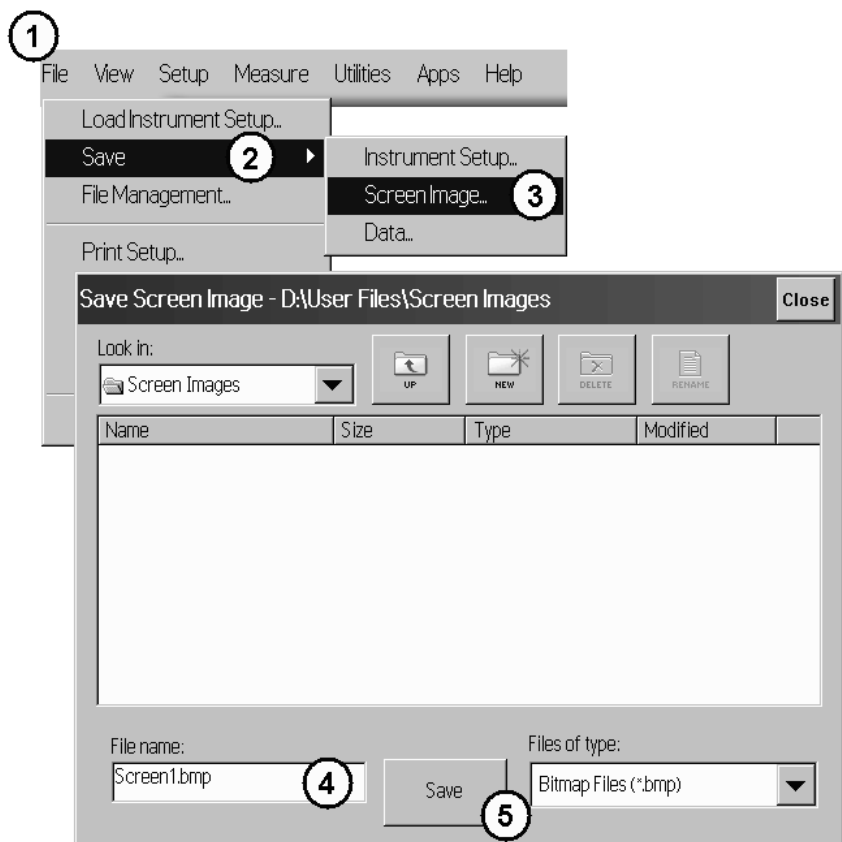

Data Logging

Data logging allows you to record measurement data over time for later analysis. Follow the steps below to set up data logging.

- 1 On the Measure menu, click Data Logging.
- 2 Enter the Logging Duration and Logging Interval time.
- 3 Click Start Data Logging.

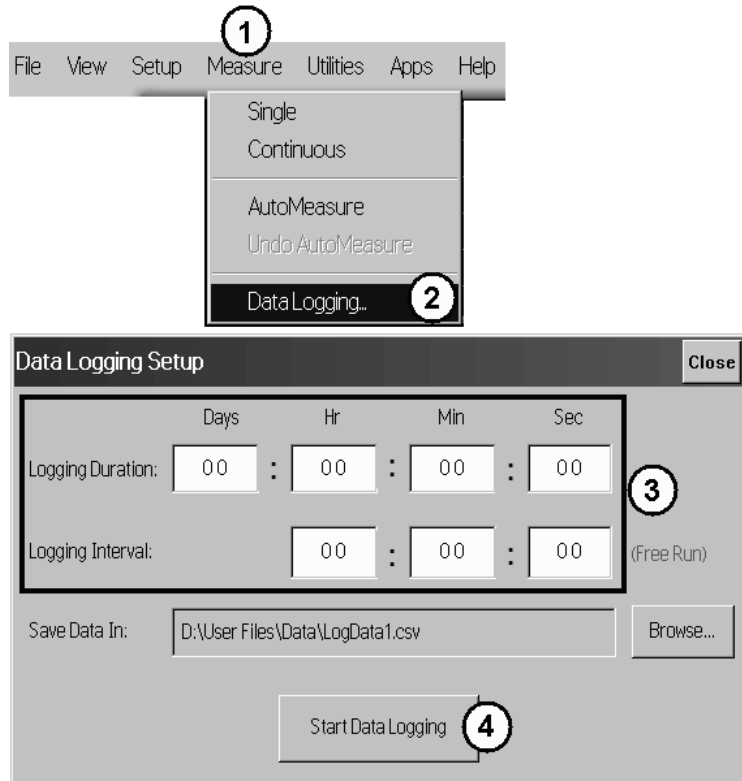

Consider the following example applications:

- To log data for a long-term stability/drift test, set the data logging duration to 24-hrs, and the interval to 5 minutes.
- To log data for a turn-on transient test (to observe how lasers change during warm-up), set the data logging duration to 5 minutes, and the interval to 0 time (free run).

Returning the Instrument for Service

The instructions in this section show you how to properly package the instrument for return to a Agilent Technologies service office. For a list of offices, [refer to “Agilent Technologies Service Offices” on page 54.](#)

If the instrument is still under warranty or is covered by an Agilent maintenance contract, it will be repaired under the terms of the warranty or contract (the warranty is at the front of this manual). If the instrument is no longer under warranty or is not covered by an Agilent maintenance plan, Agilent will notify you of the cost of the repair after examining the unit.

When an instrument is returned to a Agilent service office for servicing, it must be adequately packaged and have a complete description of the failure symptoms attached.

When describing the failure, please be as specific as possible about the nature of the problem. Include copies of additional failure information (such as the instrument failure settings, data related to instrument failure, and error messages) with the instrument being returned. Backup your measurement related data before returning the instrument to Agilent service.

Please notify the service office before returning your instrument for service. Any special arrangements for the instrument can be discussed at this time. This will help the Agilent service office repair and return your instrument as quickly as possible.

Preparing the instrument for shipping

- 1** Write a complete description of the failure and attach it to the instrument. Include any specific performance details related to the problem. The following information should be returned with the instrument.
 - Type of service required.
 - Date instrument was returned for repair.
 - Description of the problem:
 - Whether problem is constant or intermittent.
 - Whether instrument is temperature-sensitive.
 - Whether instrument is vibration-sensitive.
 - Instrument settings required to reproduce the problem.
 - Performance data.
 - Company name and return address.
 - Name and phone number of technical contact person.
 - Model number of returned instrument.
 - Full serial number of returned instrument.
 - List of any accessories returned with instrument.
- 2** Cover all front or rear-panel connectors that were originally covered when you first received the instrument.

CAUTION

Cover electrical connectors to protect sensitive components from electrostatic damage. Cover optical connectors to protect them from damage due to physical contact or dust.

CAUTION

Instrument damage can result from using packaging materials other than the original materials. Never use styrene pellets as packaging material. They do not adequately cushion the instrument or prevent it from shifting in the carton. They may also cause instrument damage by generating static electricity.

- 3** Pack the instrument in the original shipping containers. Original materials are available through any Agilent office. Or, use the following guidelines:
 - Wrap the instrument in antistatic plastic to reduce the possibility of damage caused by electrostatic discharge.
 - For instruments weighing less than 54 kg (120 lb), use a double-walled, corrugated cardboard carton of 159 kg (350 lb) test strength.

- The carton must be large enough to allow approximately 7 cm (3 inches) on all sides of the instrument for packing material, and strong enough to accommodate the weight of the instrument.
 - Surround the equipment with approximately 7 cm (3 inches) of packing material, to protect the instrument and prevent it from moving in the carton. If packing foam is not available, the best alternative is S.D-240 Air Cap™ from Sealed Air Corporation (Commerce, California 90001). Air Cap looks like a plastic sheet filled with air bubbles. Use the pink (antistatic) Air Cap™ to reduce static electricity. Wrapping the instrument several times in this material will protect the instrument and prevent it from moving in the carton.
- 4** Seal the carton with strong nylon adhesive tape.
 - 5** Mark the carton “FRAGILE, HANDLE WITH CARE”.
 - 6** Retain copies of all shipping papers.

Agilent Technologies Service Offices

Call Center

For technical assistance, you can contact your local Agilent Call Center.

- Visit <http://www.agilent.com> and click Contact Us.

Service Center

Before returning an instrument for service, you must first call the Agilent Technologies Instrument Support Center.

- Visit <http://www.agilent.com> and click Contact Us.



3

Using the 86122B

Introduction.....	56
Differences Between the 86122B and the 86120C.....	57
Front and Rear Panel Features.....	60
Main Screen Layout.....	62
Graphs and Tables.....	64
Front Panel Buttons.....	65
Menus.....	67
86122B Dialog Box Operation.....	71
Hard Drive Recovery.....	72

Introduction

The Agilent 86122B Multi-Wavelength Meter measures the wavelength and optical power of laser light in the 1270–1650 nm wavelength range. Because the 86122B simultaneously measures multiple laser lines, you can characterize dense-wavelength-division-multiplexed (DWDM) systems and the multiple lines of Fabry-Perot lasers

With the 86122B you can quickly and easily measure the following parameters:

- Up to 1000 laser lines simultaneously
- Wavelengths and powers
- Average wavelength
- Total optical power
- Laser line separation
- Laser drift (wavelength and power)
- Optical signal-to-noise ratios
- Fabry-Perot lasers

This chapter gives you an overview of the front and rear panel, and the graphical user interface. In addition, it explains the steps required to make a measurement.

Differences Between the 86122B and the 86120C

The 86122B is backward compatible with the 86120C. However, because of improvements in the 86122B, there are some operational differences from the 86120C. For your convenience, these differences are listed below:

NOTE

The command set of 86122B is compatible with 86122A.

Differences in General Operation

- Update mode and number of points: The 86120C has two update modes (normal and fast) with two different resolutions (15,047 and 7,525 data points). The 86122B has one update mode (2 sweeps/second) and increased resolution (30,093 data points).

For the 86120C, the command `CALC1:TRAN:FREQ:POIN` selects the normal (MAX) or fast (MIN) update mode. For the 86122B, this command remains for backward compatibility. Without changing the resolution of the 86122B, this command configures the queries `SENSE:DATA?` and `CALC1:DATA?` to return the number of data points used by the 86120C. To return all the data available with the 86122B, use the new parameter `EXT1` (`CALC1:TRAN:FREQ:POIN EXT1`).

- Elevation: There is no need to enter an elevation for the 86122B because it has an internal weather station. The command `SENS:CORR:ELEV` remains for backward compatibility, but has no effect on the 86122B.
- Data logging: This new feature of the 86122B allows you to record measurement data over time for later analysis.
- Drift Application: This application has been enhanced for the 86122B.
- Dropped/added channels: If the number of channels changed during a drift measurement, the 86120C would stop the measurement and generate an error. The 86122B indicates if channels have been dropped or added, and continues the drift measurement. The query `CALC3:DATA? DROP` returns the peaks that have dropped or reappeared during a drift measurement.
- Wavelength masks: The 86122B creates wavelength masks for each laser line, which limit how fast channels can drift without being measured as dropped. With each measurement sweep, these masks re-center around laser lines that have drifted less than 0.002 THz.
- Peak threshold: The 86120C peak threshold could only be set to a relative value. The 86122B peak threshold can be set to a relative or absolute value. The command `CALC2:PTHR:MOD` allows you to select between an absolute or relative peak threshold, and `CALC2:PTHR:ABS` allows you to set the absolute value.

Differences in Remote Commands

- **CALC1:TRAN:FREQ:POIN:** For the 86120C, this command selected the normal (MAX) or fast (MIN) update mode. For the 86122B, this command remains for backward compatibility. Without changing the resolution of the 86122B, this command configures the queries **SENSE:DATA?** and **CALC1:DATA?** to return the number of data points used by the 86120C. To return all the data available with the 86122B, use the new parameter **EXT1** (**CALC1:TRAN:FREQ:POIN EXT1**).
- **SENS:CORR:ELEV:** For the 86122B, this command has no affect, and remains for backward compatibility only. There is no need to enter an elevation for the 86122B because it has an internal weather station.
- **CALC3:DATA? DROP:** For the 86122B, this query returns the peaks that have dropped or reappeared during a drift measurement.
- **CALC2:PTHR:MOD:** For the 86122B, this command allows you to select between an absolute or relative peak threshold.
- **CALC2:PTHR:ABS:** For the 86122B, this command allows you to set the absolute peak threshold value.
- **CONF:** For the 86120C, this command query returned the setting to be used for the default **FETCH** or **READ** commands. For the 86122B, this command query returns the current configuration of the instrument.
- **SYST:VERS?:** This query returns the SCPI compliance version. The 86120C version was 1995.0. The 86122B version is 1999.0.
- **DISP:UNIT:WAV:** This new command allows you to set the wavelength unit of the display.
- **DISP:WIND2:** The new commands in this subsystem allow you to control or query the graphical display settings.
- **HCOP:DEST, HCOP:MODE, HCOP:PRIN:** These new commands allow you to set-up your printer and printout mode.
- **MMEM:** The new commands in this subsystem allow you to manage the mass storage capabilities of the instrument.
- **SYST:DATE** and **SYST:TIME:** These new commands allow you to set or query the date and time.
- **Questionable status register bits 4 and 12:** The 86122B uses these bits.
- **Power offset:** The 86120C does not apply the current power offset to power values returned from the **FETC:ARR/SCAL:POW?** and **CALC2:DATA? POW** commands. The 86122B does apply the power offset to these commands.
- **Inverse centimeters and inverse meters unit suffix:** The 86120C applied an incorrect conversion for values with the **/CM** or **/M** suffix when converting to a commands internal unit (often Hertz). The 86122B correctly converts **/CM** and **/M** to the corresponding internal value.

Front and Rear Panel Features

Rear Panel

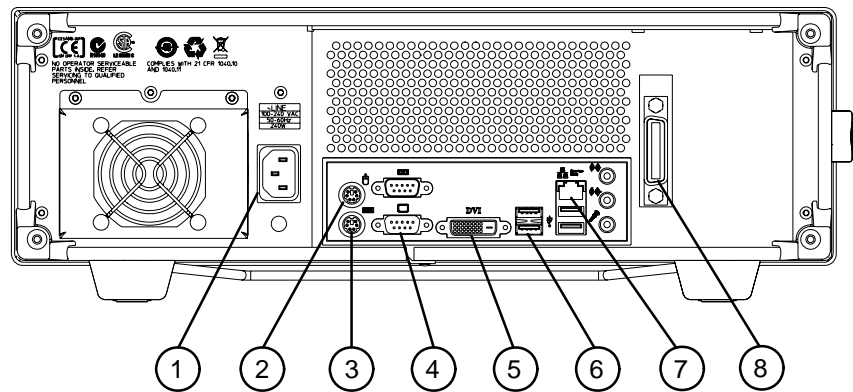

- 1 Power: AC line
- 2 Mouse: PS/2 for optional mouse
- 3 Keyboard: PS/2 for optional keyboard
- 4 Video Output: SVGA
- 5 Digital Video Output: DVI
- 6 USB: For a USB keyboard and mouse. USB and LAN printers only (no parallel printer port)
- 7 LAN: A keyboard must be used to set up LAN connectivity
- 8 GPIB: Fully programmable, complies with IEEE 488.2

Front Panel

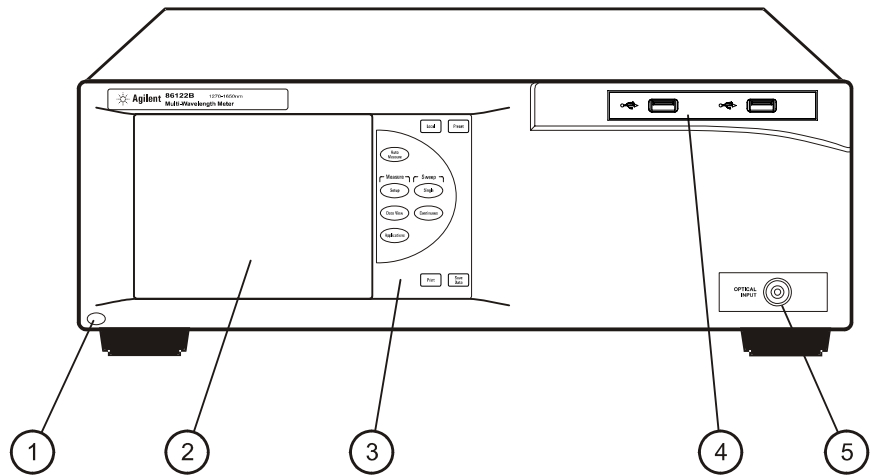

- 1 Line button
- 2 Touch screen display
- 3 Front panel buttons
- 4 Two USB 2.0 ports
- 5 Optical Input: 9/125 μm single-mode fiber

Main Screen Layout

The main screen of the 86122B is shown below:

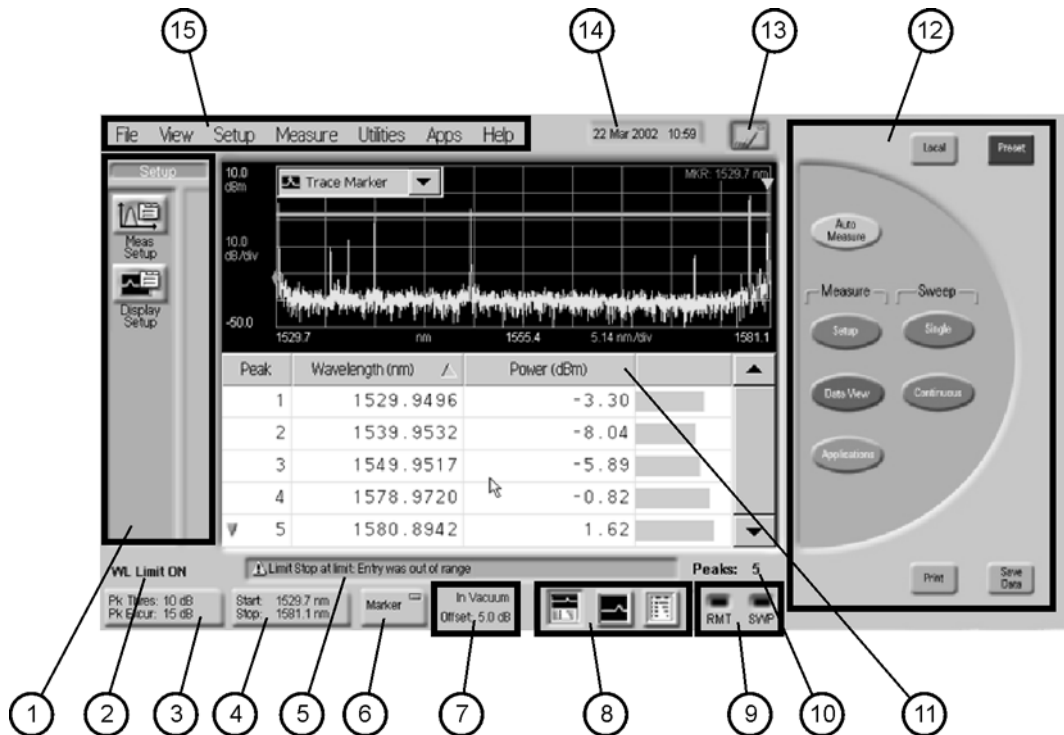

The basic main screen components are described below. For more detailed information, refer to the Help.

- 1 Instrument Toolbars:** You can use the graphical toolbar to easily access measurement setup, data view, and application functions. There is a dedicated toolbar for each function. To open the desired toolbar, press the front panel button that corresponds with the functions you want to perform.



- 2 Wavelength Limiting Status:** Displays the wavelength limiting state.
- 3 Peak Criteria Button:** Click this button to access the peak criteria settings and change the definition of peak.
- 4 Graph Limit Button:** Click this button access the graph limits settings and define the x-axis limits of the graphical display.

- 5** Error Message Display Box: This area displays information about the status of the instrument or an action that has been performed. Messages also appear to inform you of errors that may have occurred.
- 6** Marker Button: Click this button to enable or disable the trace marker.
- 7** Medium and Offset: Displays the selected medium and power offset setting.
- 8** Data Display Buttons: These buttons allow you to can select one of three types of data displays: split display, graph only, or table only.
- 9** Remote and Sweep Indicators: These indicators display the operating and acquisition status of the instrument. When the instrument is in the remote operating mode or is acquiring data, the corresponding indicator is lit.
- 10** Number of Peaks Status: This indicator displays the number of peaks currently detected that meet the specified peak criteria.
- 11** Graphical Display: The Agilent 86122B has a high-resolution touch screen that allows easy navigation of the instrument. You can also use a mouse. The graphical display shows the transformed, uncorrected frequency-domain measurement data in a spectrum analyzer type graph.
- 12** Front Panel Buttons: The 10 front panel buttons can be accessed with your finger or a stylus.
- 13** Touch Screen Enable/Disable Button: Click or touch this button to disable the pointing devices (touch screen and mouse). The indicator on the button changes from green to red.

When you disable the pointing devices, the mouse is confined to the region surrounding the disable button. You can then touch the graphical display without initiating a change to the instrument.

If you touch anywhere on the graphical display when the pointing devices are disabled, the disable button flashes yellow. To enable the pointing devices, click or touch this button again. The graphical display returns to its normal operating condition.

- 14** Set Time and Date: Click this button to access the time and date controls. The instrument uses the date and time when performing various functions. For example,
 - data logging
 - listing files in MMEMory subsystem commands
 - saving files
 - saving screen images
 - printing
- 15** Instrument Menus: The instrument menus provide access to all functions.

Graphs and Tables

This section describes the layout of the graph and table.



- A** The graph displays a measurement trace that plots wavelength versus power for the entire span of the graph.
- B** The table lists precise measurement data for peak wavelengths.
- C** The trace marker allows you to find the approximate wavelength of any point on the measurement trace. An area in the upper right corner of the graph displays the approximate trace marker wavelength, but not power.
- D** The horizontal green line represents the peak threshold, one of two criteria used to define peak wavelengths. For more information, refer to Peak Criteria.
- E** The peak marker is always displayed and allows you to associate a peak wavelength in the graph with a row of peak data in the table.

Front Panel Buttons

The touch screen extends to the right of the LCD display. This area contains ten touchkeys buttons that can be accessed with your finger or a stylus. These are referred to as the front panel buttons. This section explains the function of each front panel button.

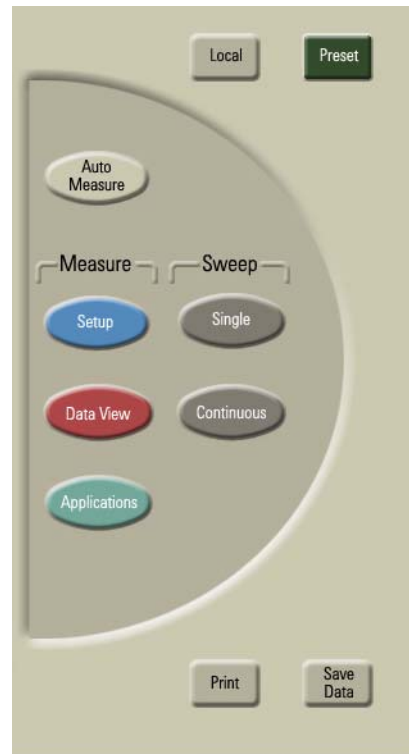

Press this button to return control of the instrument to the front panel. The Local and AC power buttons are the only front panel controls active when the instrument is in remote operation.



Press this button to return the instrument to its factory default conditions. The exceptions are:

- GPIB address
- references
- Printout type
- OSNR user wavelength
- Don't Show this Dialog on Startup check box



Press this button to exit the current measurement application and initiate an auto-measurement sequence.



Press this button to open the Setup toolbar. You can then modify a variety of measurement and display setup functions.



Press this button to open the Data View toolbar. You can then configure the tabular display as desired.



Press this button to open the Applications toolbar. You can then select your desired measurement application.



Press this button to place the instrument in single sweep mode and initiate a single sweep of the instrument.



Press this button to place the instrument in continuous sweep mode and initiate sweeping.



Press this button to open the Save Meas Data dialog box. Select a file name and click Save.



Press this button to open the Print Setup dialog box. Select the Default Printer and Printout Type, and click Print.

Menus

The instrument menus provide access to all functions. This section shows the layout of each menu. For detailed information on each of these menus, refer to the Help.

The File menu

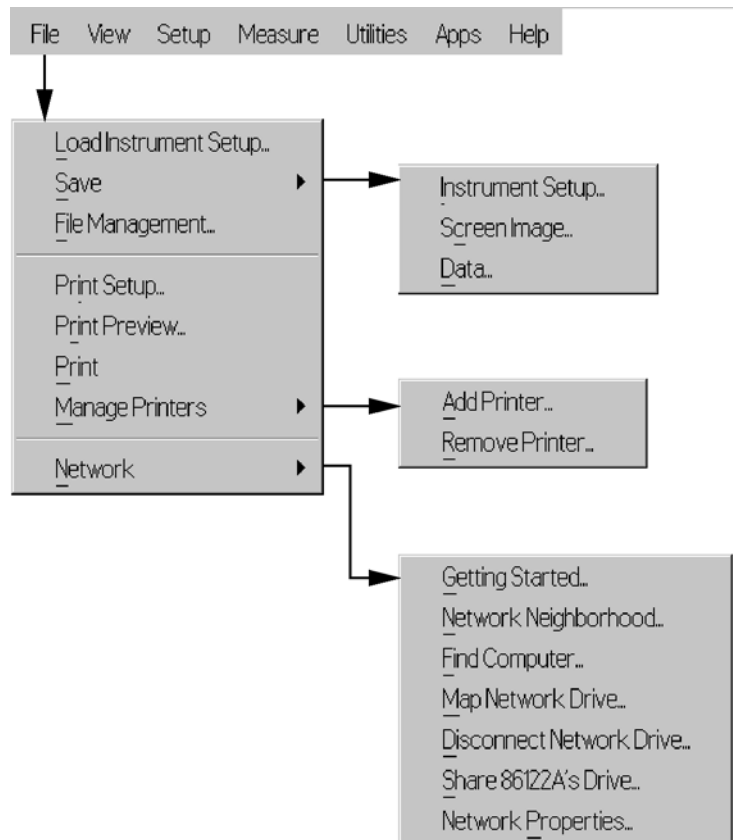

The View menu

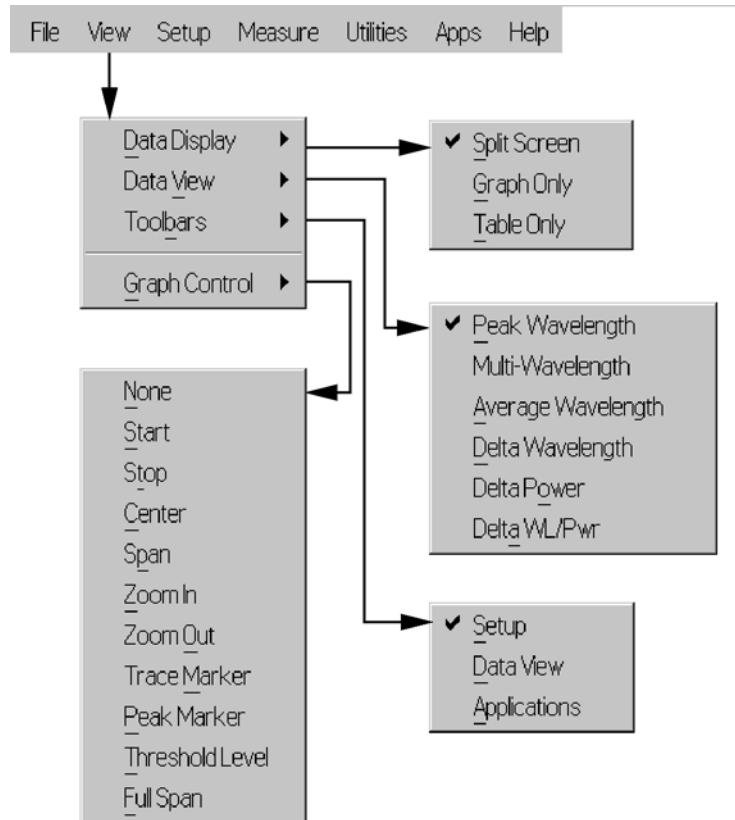

The Setup menu

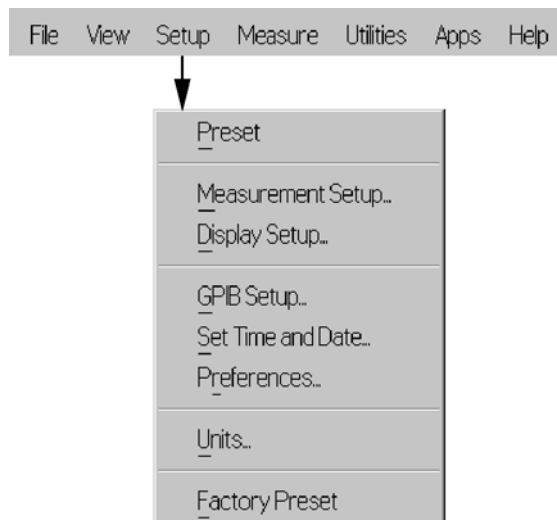

The Measure menu

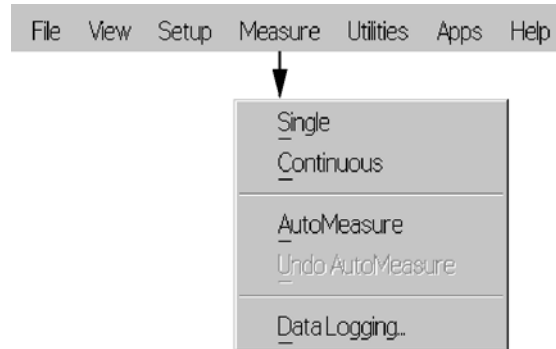

The Utilities menu

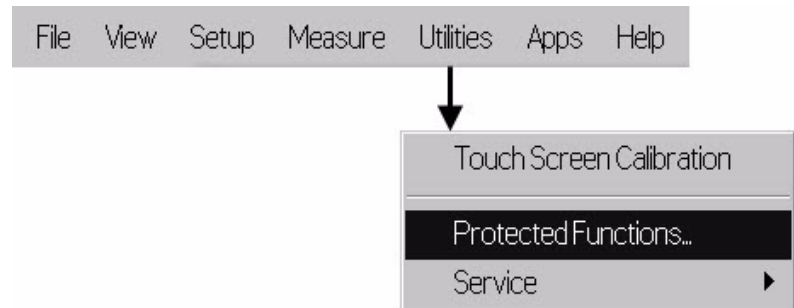

The Apps menu

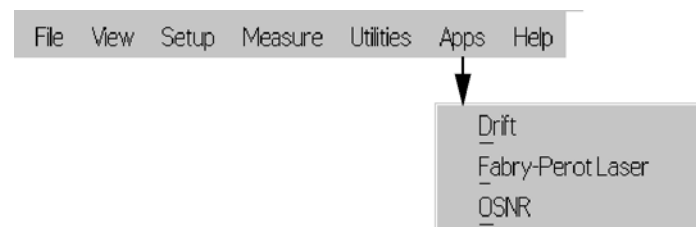

The Help menu

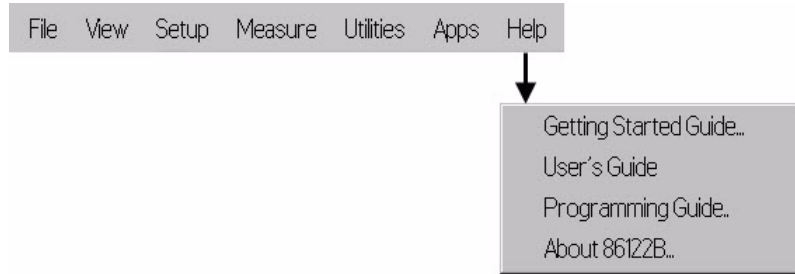

86122B Dialog Box Operation

The 86122B dialog boxes allow real-time changes to instrument settings. Because of this, the dialog boxes do not have OK, Apply, and Cancel buttons. When you have finished changing a setting, simply click Close.

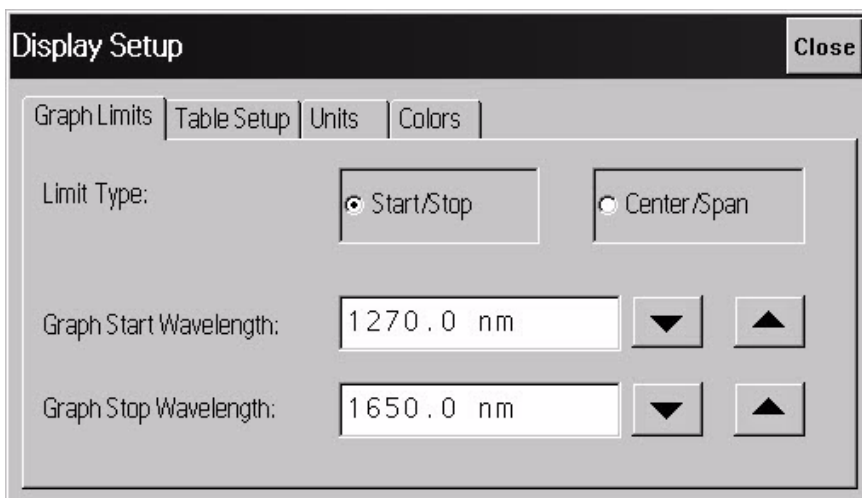

Hard Drive Recovery

For recovery purposes there is an original factory image back-up of the instrument software. This image can be restored as follows:

WARNING

All data on drive C: (system) will be overwritten by this procedure, D: (user data) will not be affected. Agilent recommends to regularly back-up your data to external media (e.g. USB hdd or USB flash memory) or to drives shared in a network.

- 1 Switch off the instrument.
- 2 Connect a USB or a PS2 keyboard to the instrument.
- 3 Switch on the instrument.
- 4 When the screen "**Windows Boot Manager**" appears press the cursor down key within 5 seconds to select the entry "**Agilent Recovery System**".
- 5 Press <Enter> key.
- 6 Wait for the dialog "**AgilentRecoverySystem.vbs**".
- 7 Press the 2 key for "**Recover the original factory system image**".
- 8 Press <Enter> key. A warning dialog will appear.
- 9 Press <Enter> key to start the recovery. When completed the instrument will restart.
- 10 Check the correct operation of the recovered system.



4

Cleaning Information

Cleaning Instructions.....	74
Safety Precautions	74
Why is it important to clean optical devices ?	75
What do I need for proper cleaning?	76
Preserving Connectors.....	80
Cleaning Instrument Housings.....	80
Which Cleaning Procedure should I use?.....	81
How to clean connectors.....	82
How to clean connector interfaces	84
How to clean bare fiber adapters.....	85
How to clean instruments with a fixed connector interface ..	86
Additional Cleaning Information.....	87
Other Cleaning Hints	88

Cleaning Instructions

The following Cleaning Instructions contain some general safety precautions, which must be observed during all phases of cleaning. Consult your specific optical device manuals or guides for full information on safety matters.

Please try, whenever possible, to use physically contacting connectors, and dry connections. Clean the connectors, interfaces, and bushings carefully after use.

If you are unsure of the correct cleaning procedure for your optical device, we recommend that you first try cleaning a dummy or test device.

Agilent Technologies assume no liability for the customer's failure to comply with these requirements.

Safety Precautions

Please follow the following safety rules:

- Do not remove instrument covers when operating.
- Ensure that the instrument is switched off throughout the cleaning procedures.
- Use of controls or adjustments or performance of procedures other than those specified may result in hazardous radiation exposure.
- Make sure that you disable all sources when you are cleaning any optical interfaces.
- Under no circumstances look into the end of an optical device attached to optical outputs when the device is operational. The laser radiation is not visible to the human eye, but it can seriously damage your eyesight.
- To prevent electrical shock, disconnect the instrument from the mains before cleaning. Use a dry cloth, or one slightly dampened with water, to clean the external case parts. Do not attempt to clean internally.
- Do not install parts or perform any unauthorized modification to optical devices.
- Refer servicing only to qualified and authorized personnel.

Why is it important to clean optical devices ?

In transmission links optical fiber cores are about 9 μm (0.00035") in diameter. Dust and other particles, however, can range from tenths to hundredths of microns in diameter. Their comparative size means that they can cover a part of the end of a fiber core, and as a result will reduce the performance of your system.

Furthermore, the power density may burn dust into the fiber and cause additional damage (for example, 0 dBm optical power in a single mode fiber causes a power density of approximately 16 million W/m^2). If this happens, measurements become inaccurate and non-repeatable.

Cleaning is, therefore, an essential yet difficult task. Unfortunately, when comparing most published cleaning recommendations, you will discover that they contain several inconsistencies. In this section, we want to suggest ways to help you clean your various optical devices, and thus significantly improve the accuracy and repeatability of your lightwave measurements.

What do I need for proper cleaning?

Some Standard Cleaning Equipment is necessary for cleaning your instrument. For certain cleaning procedures, you may also require certain Additional Cleaning Equipment.

Standard Cleaning Equipment

Before you can start your cleaning procedure you need the following standard equipment:

- Dust and shutter caps
- Isopropyl alcohol
- Cotton swabs
- Soft tissues
- Pipe cleaner
- Compressed air

Dust and shutter caps All of Agilent Technologies' lightwave instruments are delivered with either laser shutter caps or dust caps on the lightwave adapter. Any cables come with covers to protect the cable ends from damage or contamination.

We suggest these protected coverings should be kept on the equipment at all times, except when your optical device is in use. Be careful when replacing dust caps after use. Do not press the bottom of the cap onto the fiber too hard, as any dust in the cap can scratch or pollute your fiber surface.

If you need further dust caps, please contact your nearest Agilent Technologies sales office.

Isopropyl alcohol This solvent is usually available from any local pharmaceutical supplier or chemist's shop.

If you use isopropyl alcohol to clean your optical device, do not immediately dry the surface with compressed air (except when you are cleaning very sensitive optical devices). This is because the dust and the dirt is solved and will leave behind filmy deposits after the alcohol is evaporated. You should therefore first remove the alcohol and the dust with a soft tissue, and then use compressed air to blow away any remaining filaments.

If possible avoid using denatured alcohol containing additives. Instead, apply alcohol used for medical purposes.

Never try to drink this alcohol, as it may seriously damage your health.

Do not use any other solvents, as some may damage plastic materials and claddings. Acetone, for example, will dissolve the epoxy used with fiber optic connectors. To avoid damage, only use isopropyl alcohol.

Cotton swabs We recommend that you use swabs such as Q-tips or other cotton swabs normally available from local distributors of medical and hygiene products (for example, a supermarket or a chemist's shop). You may be able to obtain various sizes of swab. If this is the case, select the smallest size for your smallest devices.

Ensure that you use natural cotton swabs. Foam swabs will often leave behind filmy deposits after cleaning.

Use care when cleaning, and avoid pressing too hard onto your optical device with the swab. Too much pressure may scratch the surface, and could cause your device to become misaligned. It is advisable to rub gently over the surface using only a small circular movement.

Swabs should be used straight out of the packet, and never used twice. This is because dust and dirt in the atmosphere, or from a first cleaning, may collect on your swab and scratch the surface of your optical device.

Soft tissues These are available from most stores and distributors of medical and hygiene products such as supermarkets or chemists' shops.

We recommend that you do not use normal cotton tissues, but multi-layered soft tissues made from non-recycled cellulose. Cellulose tissues are very absorbent and softer. Consequently, they will not scratch the surface of your device over time.

Use care when cleaning, and avoid pressing on your optical device with the tissue. Pressing too hard may lead to scratches on the surface or misalignment of your device. Just rub gently over the surface using a small circular movement.

Use only clean, fresh soft tissues and never apply them twice. Any dust and dirt from the air which collects on your tissue, or which has gathered after initial cleaning, may scratch and pollute your optical device.

Pipe cleaner Pipe cleaners can be purchased from tobacconists, and come in various shapes and sizes. The most suitable one to select for cleaning purposes has soft bristles, which will not produce scratches.

There are many different kinds of pipe cleaner available from tobacco shops.

The best way to use a pipe cleaner is to push it in and out of the device opening (for example, when cleaning an interface). While you are cleaning, you should slowly rotate the pipe cleaner.

Only use pipe cleaners on connector interfaces or on feed through adapters. Do not use them on optical head adapters, as the center of a pipe cleaner is hard metal and can damage the bottom of the adapter.

Your pipe cleaner should be new when you use it. If it has collected any dust or dirt, this can scratch or contaminate your device.

The tip and center of the pipe cleaner are made of metal. Avoid accidentally pressing these metal parts against the inside of the device, as this can cause scratches.

Compressed air Compressed air can be purchased from any laboratory supplier.

It is essential that your compressed air is free of dust, water and oil. Only use clean, dry air. If not, this can lead to filmy deposits or scratches on the surface of your connector. This will reduce the performance of your transmission system.

When spraying compressed air, hold the can upright. If the can is held at a slant, propellant could escape and dirty your optical device. First spray into the air, as the initial stream of compressed air could contain some condensation or propellant. Such condensation leaves behind a filmy deposit.

Please be friendly to your environment and use a CFC-free aerosol.

Additional Cleaning Equipment

Some Cleaning Procedures need the following equipment, which is not required to clean each instrument:

- Microscope with a magnification range about 50X up to 300X
- Ultrasonic bath
- Warm water and liquid soap
- Premoistened cleaning wipes
- Polymer film
- Infrared Sensor Card

Microscope with a magnification range about 50X up to 300X

A microscope can be found in most photography stores, or can be obtained through or specialist mail order companies. Special fiber-scopes are available from suppliers of splicing equipment.

Ideally, the light source on your microscope should be very flexible. This will allow you to examine your device closely and from different angles.

A microscope helps you to estimate the type and degree of dirt on your device. You can use a microscope to choose an appropriate cleaning

method, and then to examine the results. You can also use your microscope to judge whether your optical device (such as a connector) is severely scratched and is, therefore, causing inaccurate measurements.

Ultrasonic bath Ultrasonic baths are also available from photography or laboratory suppliers or specialist mail order companies.

An ultrasonic bath will gently remove fat and other stubborn dirt from your optical devices. This helps increase the life span of the optical devices.

Only use isopropyl alcohol in your ultrasonic bath, as other solvents may damage.

Warm water and liquid soap Only use water if you are sure that there is no other way of cleaning your optical device without corrosion or damage. Do not use hot water, as this may cause mechanical stress, which can damage your optical device.

Ensure that your liquid soap has no abrasive properties or perfume in it. You should also avoid normal washing-up liquid, as it can cover your device in an iridescent film after it has been air-dried.

Some lenses and mirrors also have a special coating, which may be sensitive to mechanical stress, or to fat and liquids. For this reason we recommend you do not touch them.

If you are not sure how sensitive your device is to cleaning, please contact the manufacturer or your sales distributor.

Premoistened cleaning wipes Use pre-moistened cleaning wipes as described in each individual cleaning procedure. Cleaning wipes may be used in every instance where a moistened soft tissue or cotton swab is applied.

Polymer film Polymer film is available from laboratory suppliers or specialist mail order companies.

Using polymer film is a gentle method of cleaning extremely sensitive devices, such as reference reflectors and mirrors.

Infrared Sensor Card Infrared sensor cards are available from laboratory suppliers or specialist mail order companies.

With this card you are able to control the shape of laser light emitted. The invisible laser beam is projected onto the sensor card, then becomes visible to the normal eye as a round spot.

Take care never to look into the end of a fiber or any other optical component, when they are in use. This is because the laser can seriously damage your eyes.

Preserving Connectors

Listed below are some hints on how best to keep your connectors in the best possible condition.

Making Connections Before you make any connection you must ensure that all cables and connectors are clean. If they are dirty, use the appropriate cleaning procedure.

When inserting the ferrule of a patchcord into a connector or an adapter, make sure that the fiber end does not touch the outside of the mating connector or adapter. Otherwise you will rub the fiber end against an unsuitable surface, producing scratches and dirt deposits on the surface of your fiber.

Dust Caps and Shutter Caps Be careful when replacing dust caps after use. Do not press the bottom of the cap onto the fiber as any dust in the cap can scratch or dirty your fiber surface.

When you have finished cleaning, put the dust cap back on, or close the shutter cap if the equipment is not going to be used immediately.

Keep the caps on the equipment always when it is not in use.

All of Agilent Technologies' lightwave instruments and accessories are shipped with either laser shutter caps or dust caps. If you need additional or replacement dust caps, contact your nearest Agilent Technologies Sales/Service Office.

Immersion Oil and Other Index Matching Compounds Where it is possible, do not use immersion oil or other index matching compounds with your device. They are liable to impair and dirty the surface of the device. In addition, the characteristics of your device can be changed and your measurement results affected.

Cleaning Instrument Housings

Use a dry and very soft cotton tissue to clean the instrument housing and the keypad. Do not open the instruments as there is a danger of electric shock, or electrostatic discharge. Opening the instrument can cause damage to sensitive components, and in addition your warranty will be voided.

Which Cleaning Procedure should I use?

Light dirt

If you just want to clean away light dirt, observe the following procedure for all devices:

- Use compressed air to blow away large particles.
- Clean the device with a dry cotton swab.
- Use compressed air to blow away any remaining filament left by the swab.

Heavy dirt

If the above procedure is not enough to clean your instrument, follow one of the procedures below. Please consult “Cleaning Instructions” on page 74 for the procedure relevant for this instrument.

If you are unsure of how sensitive your device is to cleaning, please contact the manufacturer or your sales distributor.

How to clean connectors

Cleaning connectors is difficult as the core diameter of a single-mode fiber is only about 9 μm . This generally means you cannot see streaks or scratches on the surface. To be certain of the condition of the surface of your connector and to check it after cleaning, you need a microscope.

In the case of scratches, or of dust that has been burnt onto the surface of the connector, you may have no option but to polish the connector. This depends on the degree of dirtiness, or the depth of the scratches. This is a difficult procedure and should only be performed by skilled personal, and as a last resort as it wears out your connector.

WARNING

Never look into the end of an optical cable that is connected to an active source.

To assess the projection of the emitted light beam you can use an infrared sensor card. Hold the card approximately 5 cm from the output of the connector. The invisible emitted light is project onto the card and becomes visible as a small circular spot.

Preferred Procedure

Use the following procedure on most occasions.

- 1 Clean the connector by rubbing a new, dry cotton-swab over the surface using a small circular movement.
- 2 Blow away any remaining lint with compressed air.

Procedure for Stubborn Dirt

Use this procedure particularly when there is greasy dirt on the connector:

- 1 Moisten a new cotton-swab with isopropyl alcohol.
- 2 Clean the connector by rubbing the cotton-swab over the surface using a small circular movement.
- 3 Take a new, dry soft-tissue and remove the alcohol, dissolved sediment and dust, by rubbing gently over the surface using a small circular movement.
- 4 Blow away any remaining lint with compressed air.

An Alternative Procedure

A better, more gentle, but more expensive cleaning procedure is to use an ultrasonic bath with isopropyl alcohol.

- 1 Hold the tip of the connector in the bath for at least three minutes.
- 2 Take a new, dry soft-tissue and remove the alcohol, dissolved sediment and dust, by rubbing gently over the surface using a small circular movement.
- 3 Blow away any remaining lint with compressed air.

How to clean connector interfaces

CAUTION

Be careful when using pipe-cleaners, as the core and the bristles of the pipe-cleaner are hard and can damage the interface.

Do not use pipe-cleaners on optical head adapters, as the hard core of normal pipe cleaners can damage the bottom of an adapter.

Preferred Procedure

Use the following procedure on most occasions.

- 1 Clean the interface by pushing and pulling a new, dry pipe-cleaner into the opening. Rotate the pipe-cleaner slowly as you do this.
- 2 Then clean the interface by rubbing a new, dry cotton-swab over the surface using a small circular movement.
- 3 Blow away any remaining lint with compressed air.

Procedure for Stubborn Dirt

Use this procedure particularly when there is greasy dirt on the interface:

- 1 Moisten a new pipe-cleaner with isopropyl alcohol.
- 2 Clean the interface by pushing and pulling the pipe-cleaner into the opening. Rotate the pipe-cleaner slowly as you do this.
- 3 Moisten a new cotton-swab with isopropyl alcohol.
- 4 Clean the interface by rubbing the cotton-swab over the surface using a small circular movement.
- 5 Using a new, dry pipe-cleaner, and a new, dry cotton-swab remove the alcohol, any dissolved sediment and dust.
- 6 Blow away any remaining lint with compressed air.

How to clean bare fiber adapters

Bare fiber adapters are difficult to clean. Protect from dust unless they are in use.

CAUTION

Never use any kind of solvent when cleaning a bare fiber adapter as solvents can damage the foam inside some adapters.

They can deposit dissolved dirt in the groove, which can then dirty the surface of an inserted fiber.

Preferred Procedure

Use the following procedure on most occasions.

- 1 Blow away any dust or dirt with compressed air.

Procedure for Stubborn Dirt

Use this procedure particularly when there is greasy dirt on the adapter:

- 1 Clean the adapter by pushing and pulling a new, dry pipe-cleaner into the opening. Rotate the pipe-cleaner slowly as you do this.

CAUTION

Be careful when using pipe-cleaners, as the core and the bristles of the pipe-cleaner are hard and can damage the adapter.

- 2 Clean the adapter by rubbing a new, dry cotton-swab over the surface using a small circular movement.
- 3 Blow away any remaining lint with compressed air.

How to clean instruments with a fixed connector interface

You should only clean instruments with a fixed connector interface when it is absolutely necessary. This is because it is difficult to remove any used alcohol or filaments from the input of the optical block.

It is important, therefore, to keep dust caps on the equipment at all times, except when your optical device is in use.

If you do discover filaments or particles, the only way to clean a fixed connector interface and the input of the optical block is to use compressed air.

If there are fluids or fat in the connector, please refer the instrument to the skilled personnel of Agilent's service team.

CAUTION

Only use clean, dry compressed air. Make sure that the air is free of dust, water, and oil. If the air that you use is not clean and dry, this can lead to filmy deposits or scratches on the surface of your connector interface. This will degrade the performance of your transmission system.

Never try to open the instrument and clean the optical block by yourself, because it is easy to scratch optical components, and cause them to be misaligned.

Additional Cleaning Information

The following cleaning procedure may be used with other optical equipment:

How to clean bare fiber ends

Bare fiber ends are often used for splices or, together with other optical components, to create a parallel beam. The end of a fiber can often be scratched. You make a new cleave. To do this:

- 1 Strip off the cladding.
- 2 Take a new soft-tissue and moisten it with isopropyl alcohol.
- 3 Carefully clean the bare fiber with this tissue.
- 4 Make your cleave and immediately insert the fiber into your bare fiber adapter in order to protect the surface from dirt.

Other Cleaning Hints

Selecting the correct cleaning method is an important element in maintaining your equipment and saving you time and money. This Appendix highlights the main cleaning methods, but cannot address every individual circumstance.

This section contain some additional hints which we hope will help you further. For further information, please contact your local Agilent Technologies representative.

Making the connection Before you make any connection you must ensure that all lightwave cables and connectors are clean. If not, then use appropriate the cleaning methods.

When you insert the ferrule of a patchcord into a connector or an adapter, ensure that the fiber end does not touch the outside of the mating connector or adapter. Otherwise, the fiber end will rub up against something which could scratch it and leave deposits.

Lens cleaning papers Note that some special lens cleaning papers are not suitable for cleaning optical devices like connectors, interfaces, lenses, mirrors and so on. To be absolutely certain that a cleaning paper is applicable, please ask the salesperson or the manufacturer.

Immersion oil and other index matching compounds Do not use immersion oil or other index matching compounds with optical sensors equipped with recessed lenses. They are liable to dirty the detector and impair its performance. They may also alter the property of depiction of your optical device, thus rendering your measurements inaccurate.

Cleaning the housing and the mainframe When cleaning either the mainframe or the housing of your instrument, only use a dry and very soft cotton tissue on the surfaces and the numeric pad.

Never open the instruments as they can be damaged. Opening the instruments puts you in danger of receiving an electrical shock from your device, and renders your warranty void.



5

Specifications and Regulatory Information

Definitions of Terms.....	90
Specifications.....	92
Compliance with German Noise Requirements.....	96
Compliance with Canadian EMC Requirements.....	96
Declaration of Conformity.....	97

Definitions of Terms

Characteristics and Specifications

The distinction between specifications and characteristics is described as follows:

- Specifications describe warranted performance.
- Characteristics provide useful, but non-warranted information about the functions and performance of the instrument.
- General Characteristics give additional information for using the instrument. These are general descriptive terms that do not imply a level of performance.

Wavelength

- Range refers to the allowable wavelength range of the optical input signal.
- Absolute accuracy indicates the maximum wavelength error over the allowed environmental conditions.
- Differential accuracy indicates the maximum wavelength error in measuring the wavelength difference between two signals that are simultaneously present.
- Minimum resolvable separation indicates the minimum wavelength separation of two laser lines input required to measure each wavelength simultaneously. Two laser lines closer in wavelength than the minimum resolvable separation are not resolved and one average wavelength is displayed.
- Display resolution indicates the minimum incremental change in displayed wavelength.

Power

- Calibration accuracy indicates the maximum power calibration error at the specified wavelengths over the allowed environmental conditions.
- Flatness refers to the maximum amplitude error in a measurement between two lines that are separated in wavelength by no more than the specified amount.
- Linearity indicates the maximum power error in measuring the change in power of one laser line.
- Polarization dependence indicates the maximum displayed power variation as the polarization of the input signal is varied.
- Display resolution indicates the minimum incremental change in displayed power.

Sensitivity

- Sensitivity is defined as the minimum power level of a single laser line input to measure wavelength and power accurately. A laser line with less than the minimum power may be measured but with reduced wavelength and power accuracy. For multiple laser lines input, sensitivity may be limited by total input power.

Selectivity

- Selectivity indicates the ability to measure the wavelength and power of a weak laser line in the proximity of a specified stronger laser line and separated by the specified amount.

Input power

- Maximum displayed level indicates the maximum total input power (total of all laser lines present) to accurately measure wavelength and power.
- Maximum safe input power indicates the maximum total input power (total of all laser lines present) to avoid permanent optical damage to the instrument.

Maximum number of lines input

Maximum number of lines input is the maximum number of displayed lines. If more than the specified number of lines is input, only the longest wavelength lines are displayed.

Input return loss

Input return loss indicates the optical power reflected back to the user's fiber cable relative to the input power. It is limited by the return loss of the front panel connector, and assumes the user's connector is good.

Measurement cycle time

Measurement cycle time refers to the cycle time when measuring wavelength and power of laser lines. Specific advanced applications may require longer cycle times.

Specifications

Table 5 Specifications

Description	86122B	Notes
Wavelength		
Range	1270-1650 nm (182-236 THz)	For lines separated by less than the specified amount, wavelength accuracy is reduced.
Absolute Accuracy	±0.2 ppm	
at 1550 nm	±0.3 pm	
at 1310 nm	±0.3 pm	
for laser lines separated by	≥ 10 GHz	
Differential Accuracy ^[1]	±0.15 ppm	
Minimum Resolvable Separation ^[1] (equal power lines input)	5 GHz	
at 1550 nm	0.04 nm	
at 1310 nm	0.03 nm	
for laser lines separated by	≥ 10 GHz	
Display Resolution	0.0001 nm	
Units	nm (vacuum or standard air), cm ⁻¹ , THz	
Power		
Calibration Accuracy ^[2]	±0.5 dB (at ±30 nm from 1310 and 1550 nm)	
Flatness ^[1]	±0.2 dB (1270 to 1600 nm) ±0.5 dB (1270 to 1650 nm)	30 nm from any wavelength
Linearity	±0.3 dB (1270 to 1600 nm)	Lines above -30 dBm
Polarization Dependence	±0.5 dB (1270 to 1600 nm) ±1.0 dB ^[1] (1600 to 1650 nm)	
Display Resolution	0.01 dB	
Units	dBm, mW, μW	
Sensitivity		
Single Line Input	-32 dBm (1270 to 1600 nm) -22 dBm (1600 to 1650 nm)	
Multiple Lines Input ^[1]	30 dB below total input power, but not less than single line input sensitivity	

Table 5 Specifications

Description	86122B	Notes
Selectivity ^[1]	25 dB (spacing \geq 90 GHz) 10 dB (spacing \geq 10 GHz)	
Input Power		
Maximum Displayed Level Maximum Safe Input Level	+10 dBm +18 dBm	Sum of all lines input
Return Loss With Non-Angled Connectors (PC, Option 021) With Angled Connectors (APC, Option 022)	\geq 35 dB \geq 50 dB	
Measurement Cycle Time	0.5 s	
Maximum Number of Lines ^[3]	1000	
Measurement Modes	List by wavelength table, list by power table, signal wavelength and power, average wavelength and total power	Data logging and sorting by any parameter are included.
Delta Modes	Delta wavelength, delta power, delta wavelength and power	
Built in Automatic Measurement Applications		
Signal to Noise Ratio ^{[1][4]} Channel Spacing \geq 100 GHz Channel Spacing \geq 50 GHz	>35 dB with 100 averages >27 dB with 100 averages	0.1 nm noise bandwidth, lines above -25 dBm.
Drift	Maximum, minimum, total drift (max-min) of wavelengths and powers over time	
Fabry-Perot Characterization	Mean wavelength, peak wavelength, mode spacing full-width half maximum, peak amplitude total power, sigma	
Additional Features	Power offset, power bars (on or off), user adjustable peak excursion and peak threshold, user adjustable start and stop wavelength limits, graphical display, save and recall instrument states.	
Inputs/Outputs		
Optical Input	9 μ m/125 μ m single-mode fiber	
Rear Panel Connectors	LAN, PS/2 for Keyboard & Mouse, SVGA and DVI for external monitor, GPIB, USB.	

Table 5 Specifications

Description	86122B	Notes
Dimensions and Weight		
Dimensions (H x W x D)	138 mm x 425 mm x 520 mm (5.2 in x 16.7 in x 20.5 in)	
Weight	14.5 kg (32 lb)	
Environmental		
Operational		
Temperature	15 °C to 35 °C	
Humidity ^[5]	< 75% R.H. at 35 °C	
Shock ^[5]	120 g	Half sine, 2 msec pulse
Vibration ^[5]	2 g rms	Random, 5 Hz to 500 Hz, 10 min./axis Sine, 5 Hz to 500 Hz, 1 octave/min.
	0.5 g (0 to peak)	
Storage		
Temperature	-40 °C to +70 °C	
Humidity ^[5]	95% R.H. at +40 °C 5 day cycle	Non-condensing
Power requirements		
Voltage and frequency	100 V / 115 V / 230 V / 240 V~, 50 Hz / 60 Hz	
Maximum power	310 VA max	
General Characteristics		
HeNe Laser Typical operating lifetime	15000 h	The 8612x wavelength meters contain HeNe reference lasers, which have limited operating lifetimes, like all gas-discharge lasers. The 86122B has a different specially stabilized laser for the higher wavelength accuracy, so this lifetime is an important maintenance factor.

^[1]Characteristic.

^[2]Excluding polarization effects.

^[3]Number of laser lines may be limited by signal power requirements for accurate wavelength measurement.

^[4]At 1550 nm.

^[5]Type tested means tested, but not warranted, for continuous operation.

Compliance with German Noise Requirements

This is to declare that this instrument is in conformance with the German Regulation on Noise Declaration for Machines (Laermangabe nach der Maschinenlaermverordnung -3.GSGV Deutschland).

Table 6 Notice for Germany: Noise Declaration

Acoustic Noise Emission	Geraeuschemission
LpA < 70 dB	LpA < 70 dB
Operator position	am Arbeitsplatz
Normal position	normaler Betrieb
per ISO 7779	nach DIN 45635-1

Compliance with Canadian EMC Requirements

This ISM device complies with Canadian ICES-001.

Cet appareil ISM est conforme a la norme NMB-001 du Canada.

Declaration of Conformity

 Agilent Technologies	DECLARATION OF CONFORMITY According to EN ISO/IEC 17050-1:2004	
---	--	---

Manufacturer's Name: Agilent Technologies Singapore (International) Pte. Ltd.
Manufacturer's Address: No. 1 Yishun Ave 7
 SINGAPORE 768923
 Singapore

Declares under sole responsibility that the product as originally delivered

Product Name: Multi Wavelength Meter
Product Number: 86122B
Product Options: *This declaration covers all options of the above system.*

complies with the essential requirements of the following applicable European Directives, and carries the CE marking accordingly:

- The Low Voltage Directive 2006/95/EC
- The EMC Directive 2004/108/EC

and conforms with the following product standards:

EMC	Standard	Limit
	IEC 61326-1:2005 / EN 61326-1:2006	
	<i>Reference Standards</i>	
	CISPR 11:2003 / EN 55011:1998+A1:1999+A2:2002 IEC 61000-4-2:2001 / EN 61000-4-2:1995+A1:1998+A2:2001 IEC 61000-4-3:2002+A1:2002 / EN 61000-4-3:2002+A1:2002 IEC 61000-4-4:2004 / EN 61000-4-4:2004 IEC 61000-4-5:2001 / EN 61000-4-5:1995+A1:2001 IEC 61000-4-6:2003 / EN 61000-4-6:1996+A1:2001 IEC 61000-4-8:1993+A1:2000 / EN 61000-4-8:1993+A1:2001 IEC 61000-4-11:2004 / EN 61000-4-11:2004	Group 1 Class A 4 kV CD, 4 kV AD 3 V/m / 80 MHz-2 GHz, 1V/m / 2-2.7 GHz 0.5 kV signal lines, 1 kV power lines 0.5 kV line-line, 1 kV line-ground 3 V, 0.15-80 MHz 30A/m 0% for 1/0.5 (0°, 180°) cycle 0% for 250/300 cycles 70% for 25/30 cycles
	Canada: ICES/NMB-001:2004 Australia/New Zealand: AS/NZS CISPR 11:2004	
Safety	IEC 61010-1:2001 / EN 61010-1:2001 IEC 60825-1:2007 / EN 60825-1:2007 Canada: CAN/CSA-C22.2 No. 61010-1:2004 USA: UL 61010-1:2004; FDA 21CFR1040.10+Laser Notice No. 50	

Supplementary Information:

(1) FDA Accession Number 9521220
 The product was tested in a typical configuration with Agilent Technologies test systems.
 This DoC applies to above-listed products placed on the EU market after:

2011-March-01
 Date

 Hans-Martin Fischer
 Name
 Product Quality & Compliance
 Title

For further information, please contact your local Agilent Technologies sales office, agent or distributor, or Agilent Technologies Deutschland GmbH, Herrenberger Straße 130, 71034 Boeblingen, Germany.

© Agilent Technologies, Inc. 2002 - 2011

First edition, April 2011



86122-90B01