

ADVANTEST

Q8384
Optical Spectrum Analyzer

Can measure and evaluate ultra high-speed optical DWDM transmission systems, and optical components at high wavelength resolution and high accuracy. New high-end optical spectrum analyzer adopting a new monochromator system.

- 10 pm resolution bandwidth
- 20 pm wavelength accuracy
- Wide dynamic range: 50 dB (± 0.1 nm), 60 dB (± 0.2 nm)
- Accurate NF measurement on EDFAs
- Can handle power levels as high as +23 dBm (200 mW)
- GATED MEAS mode for loop testing
- Abundance of WDM analysis features



Q8384

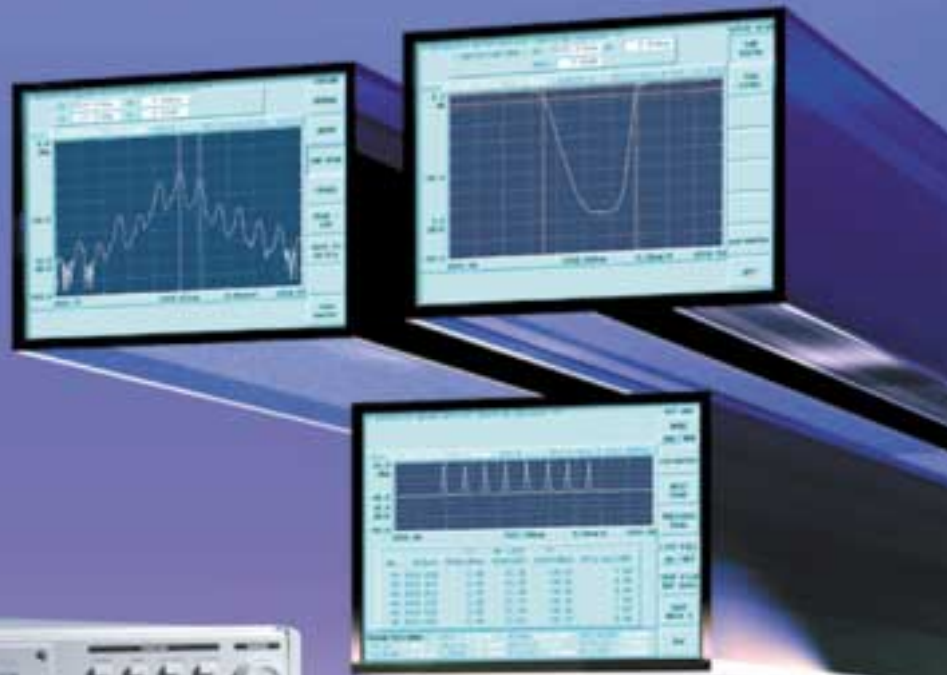



High-end Optical Spectrum Analyzer Q8384



The Advantest Q8384 is a high-end optical spectrum analyzer with a new unique monochromator system featuring high wavelength resolution united with wide dynamic range.

In DWDM optical communication, exacting oscillation wavelength characteristics are required of the laser diode. Evaluating these specifications requires an optical spectrum analyzer with enhanced resolution bandwidth and wavelength accuracy. To meet these particular requirements, the Q8384 has realized a resolution bandwidth of 10 pm. It also attains a wavelength accuracy of 20 pm at the 1550 nm band, which is the top by world standards. This high performance makes it possible for the Q8384 to measure the oscillation wavelength characteristics of laser diodes accurately.

DWDM optical communication systems also entail wavelength division multiplexing channels spaced at 50 GHz (0.4 nm) intervals or closer in wavelength. In this environment an optical spectrum analyzer with superior dynamic range is required to separate the optical signals and measure the noise factor (NF) of the optical amplifier. The Q8384 has a dynamic range as wide as 50 dB at 0.1 nm and 60 dB at 0.2 nm and therefore fulfills these requirements adequately. Equipped with automatic optical amplifier NF measurement and arithmetic facilities, the instrument allows the user to make measurements in a simple fashion.

The Q8384 optionally has a built-in reference wavelength light source and an EE-LED (edge emitting LED). If calibrated with this reference light source, the instrument is assured to provide wavelength accuracy. Using the EE-LED's broad-band light source, the Q8384 allows the user to conveniently measure and evaluate the transmission and loss characteristics of narrow-band optical filters.

Excellent Basic Performance

10 pm high wavelength resolution

The Q8384 has realized a wavelength resolution as high as 10 pm through the employment of a newly developed monochromator system. This makes it possible to measure and evaluate the side bands of optical signals which are intensively modulated at 10 Gbps, a task formerly impossible with conventional spectrum analyzers.

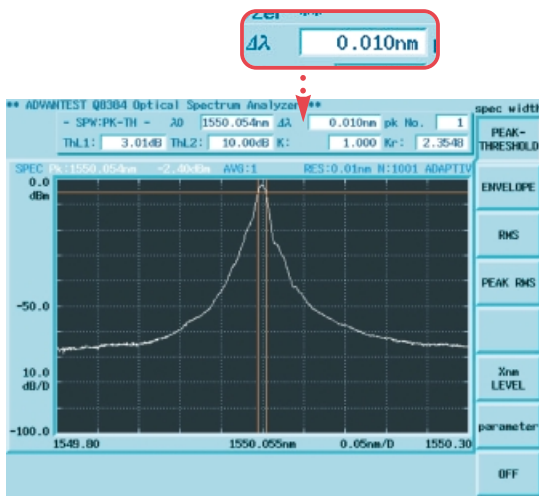

FIG. 1 Resolution band width of 10 pm

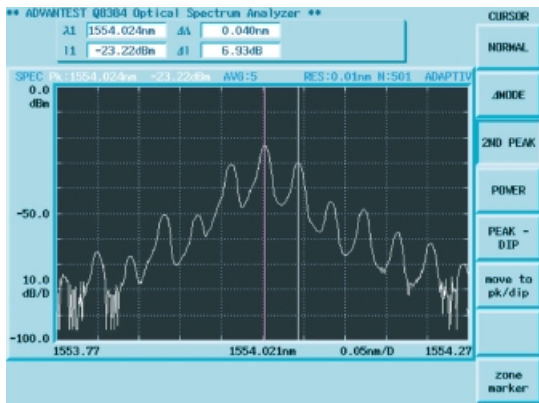

FIG. 2 Sample Waveform Modulated at 10 Gbps

20 pm high wavelength accuracy

The Q8384 can measure wavelengths at an accuracy of ± 20 pm within the wavelength range of 1530 to 1570 nm and at ± 40 pm within the L-band range of 1570 to 1610 nm after being calibrated with the built-in calibration light source (option 25). It can accurately evaluate the exacting characteristics of laser diodes and optical filters used in DWDM transmission systems. Since the Q8384 provides a wavelength linearity of ± 10 pm for the wavelength band of 1530 to 1570 nm, it can accurately measure the wavelength interval of wavelength division multiplexed signals.

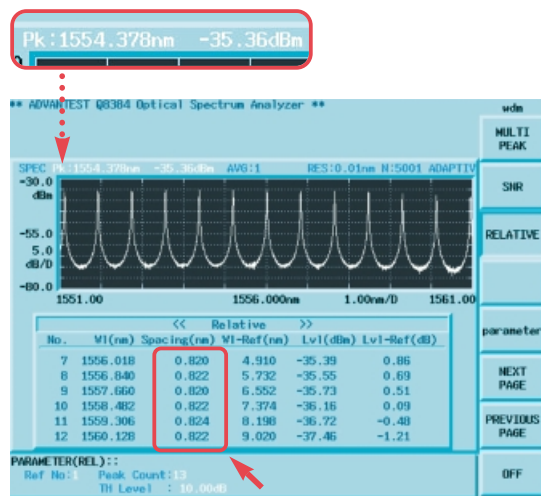
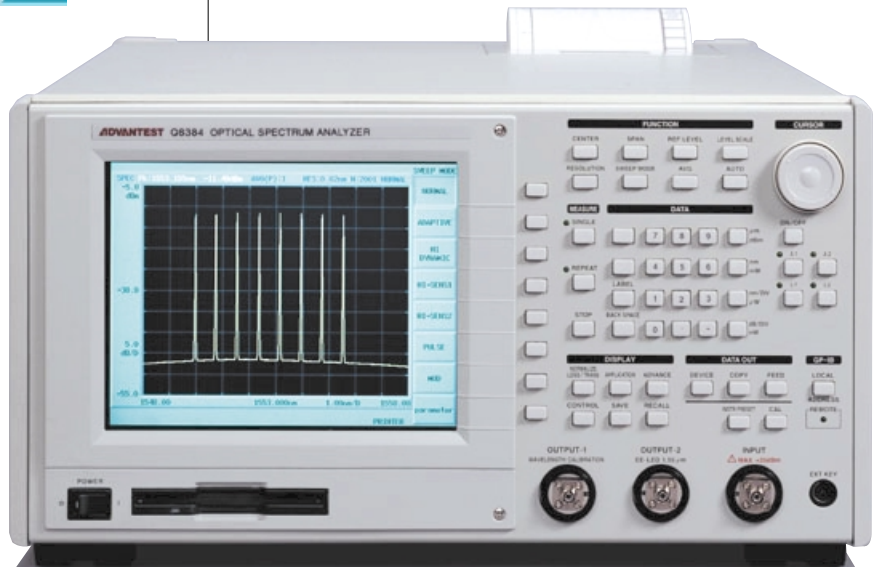

FIG. 3 A measurement example of a Fabry-Perot filter
Wavelength spacing can be measured with satisfactory linearity.



50 dB (± 0.1 nm)/60 dB (± 0.2 nm) wide dynamic ranges

Signals are subject to wavelength division multiplexing spaced at 50 GHz (0.4 nm) or shorter intervals in a DWDM. An optical spectrum analyzer with superior dynamic range is required to separate and measure these tightly spaced signals. The Q8384 has realized a dynamic range of as wide as 60 dB at 0.2 nm enabling it for this arduous task. At 0.1 nm, the instrument provides a dynamic range of 50 dB enabling it to support future DWDMs with signals at even shorter intervals.

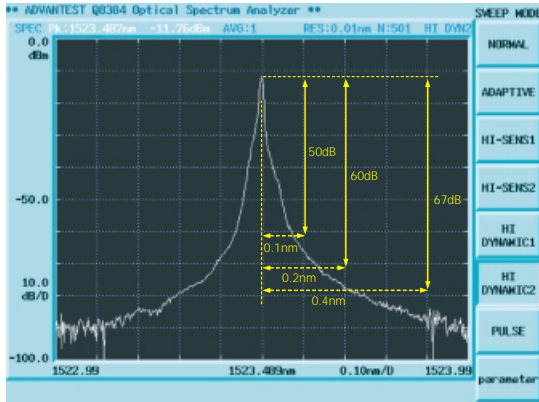

FIG. 4 Dynamic range

+23 dBm (200 mW) high-power direct input

The Q8384 can directly measure high-power signals from fiber amplifiers or pumped laser diodes without attenuation.

Abundance of analysis facilities

Measuring the noise factor of an optical fiber amplifier

The Q8384 makes one-touch measurements with high accuracy possible through performance enhancement in dynamic range, dependency on polarized light, level accuracy, linearity, wavelength resolution setting accuracy, etc. and applying curve fitting and other functions.

Since the Q8384 can adequately separate the ASE level of signals from a DWDM that are multiplexed at intervals of 50 GHz (0.4 nm) or wider, it provides not only the capability to perform accurate noise factor measurements but also the capability to show a listing of multiple measurement results at the same time.

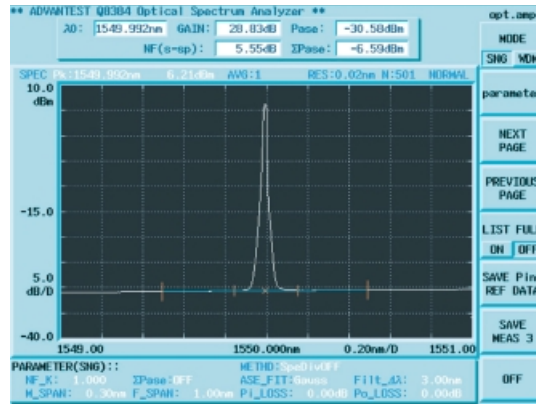

FIG. 5 Diagram of NF Measurement Using the Interpolation Method

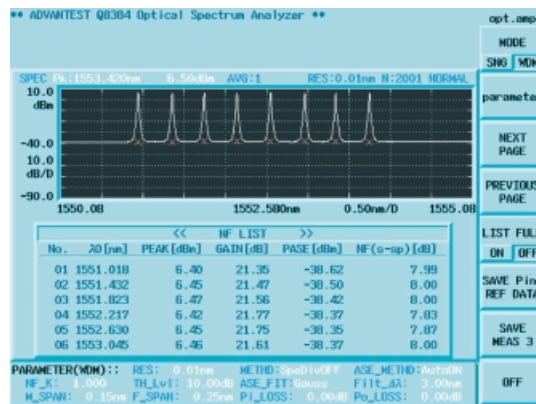

FIG. 6 An example of measurement, DWDM (50 GHz) NF

The measured waveform and a list of the obtained measurements are displayed at the same time.

WDM Analysis feature

The Q8384 can display a maximum of 128 peak wavelengths and power levels of WDM signals. It can show wavelength and power level as deviations from the channel spacing or from a reference signal as well as in absolute values.

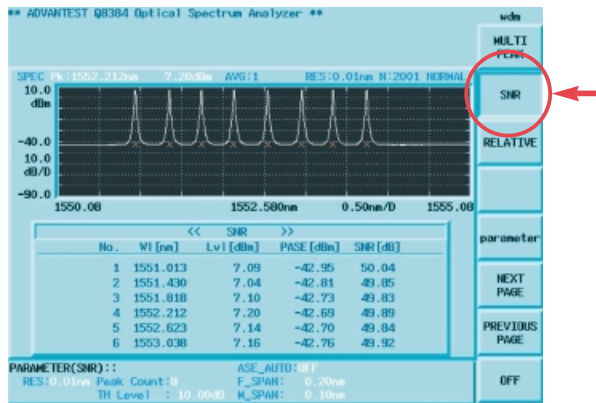

FIG. 7 SNR Display

Wavelength-specific S/N ratio measurements are displayed.

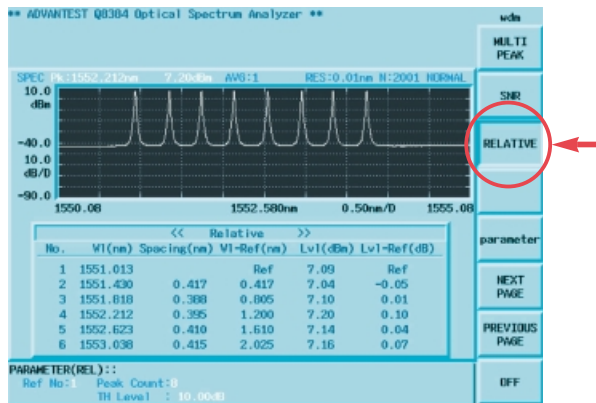

FIG. 8 Relative Display

Differences from channel spacing and a reference signal are displayed.

Alternate sweep feature

The Q8384 can show two types of data with different setup conditions in two windows. These windows are always rewritable using the alternate sweep feature of the Q8384. With this feature the user can make detailed measurements of signals in a specific wavelength band while monitoring the entire wavelength area of the WDM system.

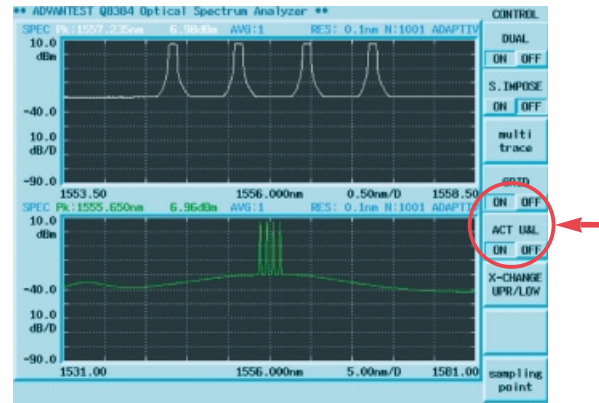

FIG. 9 WDM Alternate Sweeping

Upper: 5 nm SPAN, Lower: 50 nm SPAN

Pulse measuring function

Performing a long-distance transmission experiment using loop tests requires an optical spectrum analyzer with a sweep function triggered by an external gate signal. The Q8384 supports loop tests using an externally synchronized sweep function. It can measure very weak signals satisfactorily since it has a high sensitivity of approximately -65 dBm.

Moreover, a pulse sweeping function makes it possible to measure a peak value of the measured light. Even pulsed light can thus be measured without any missing portion.

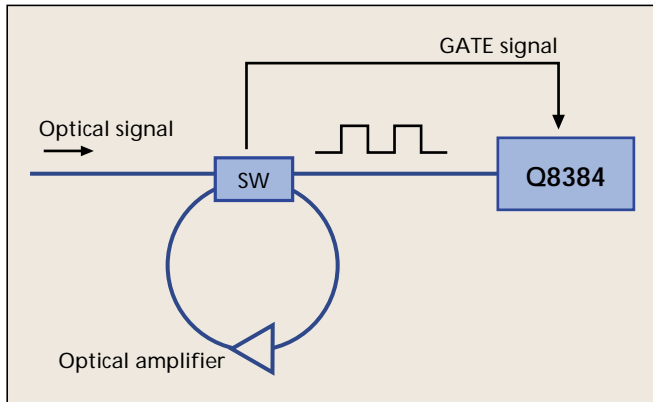

FIG. 10 Outline of a Loop Test

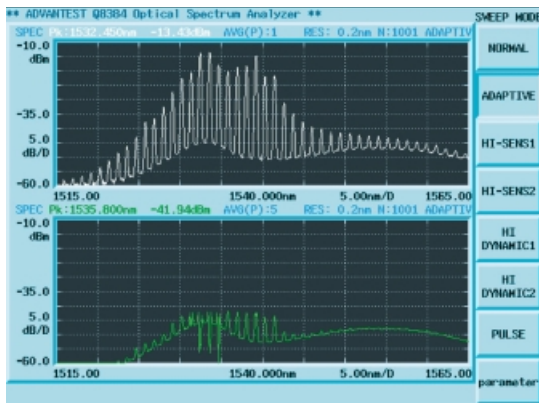

FIG. 11 Upper: externally synchronized sweep, Lower: normal sweep

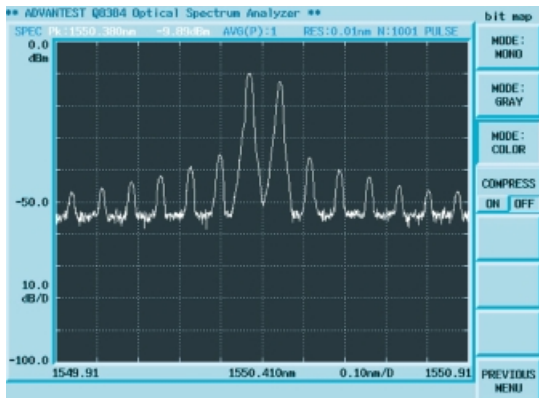

FIG. 12 An example of measuring four wave mixing by pulse sweeping

Transmission and loss measuring function

In conventional transmission/loss measurements for an optical filter, it was necessary to measure a reference signal in advance and then carry out the intended measurements on the real signal under the same conditions. Since the Q8384 is provided with a built-in zoom feature, the user can make transmission and loss measurements while varying the center wavelength and measurement span freely within the wavelength range of the reference signal once the reference signal is measured in a wide wavelength range. The user does not need to measure the reference signal every time a different sample is used, thus enabling efficient measurement of transmission and loss characteristics. The Q8384 also permits one-touch measurement of cutoff frequency range of notch filters using a fiber grating filter and the pass band of band pass filters.

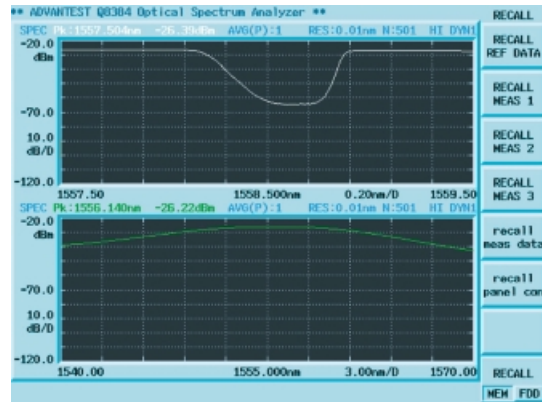

FIG. 13 Upper: measuring signal, 2 nm SPAN. Lower: reference signal, 30 nm SPAN
Although prior measurement systems require that reference and measuring signals be put under same conditions, Q8384 enables measurement even if these signals are under different conditions.

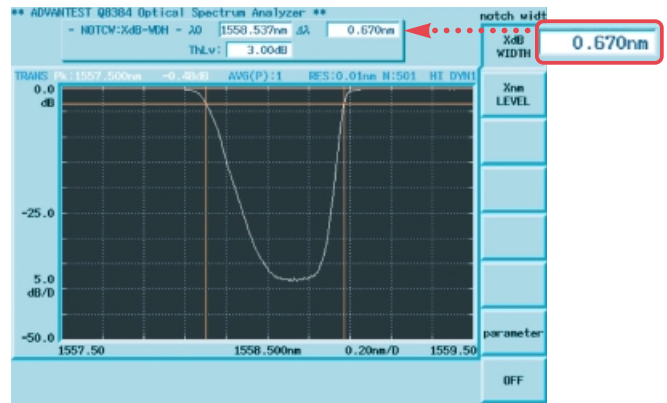

FIG. 14 Notch filter: wavelength width at 3 dB loss

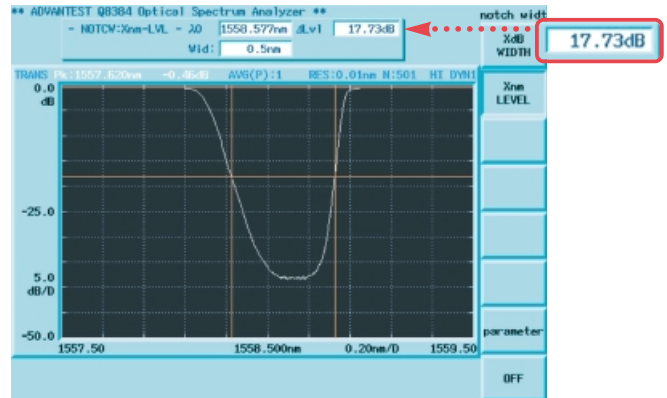

FIG. 15 Notch filter: loss measurement with a wavelength width of 0.5 nm

Various data storage media

The Q8384 can store data in two formats with the built-in standard floppy disk drive.

TEXT format (numeric format)

All measurement conditions and data are stored on a floppy disk. The stored data may be restored by the Q8384 or read directly with a personal computer. It is possible to edit and manage the measured data on a personal computer using spreadsheet software.

BITMAP format

The BITMAP format is used to store a bitmap image of measured data on a floppy disk with no data manipulation. Using image editing software, the user can manage data from the screen directly on the personal computer. Additionally, the built-in high-speed thermal printer allows the user to take hardcopy images of measured data.

Abundance of standard I/O interfaces

The standard Q8384 comes not only with a GPIB interface but also a Centronics I/O interface for connecting an external printer. This is useful for document preparation.

Performance Parameters

Wavelength

Measurement range:	600 to 1700 nm
Accuracy:	≤±500 pm
Accuracy *1:	≤±200 pm (after user calibration) ≤±20 pm (after calibration with built-in high source, 1530 to 1570 nm) ≤±40 pm (after calibration with built-in high source, 1570 to 1610 nm)
Straight line *1:	≤±10 pm (1530 to 1570 nm) ≤±20 pm (1570 to 1610 nm)
Repeatability *1,*4:	≤±3 pm (1530 to 1610 nm)

Wavelength resolution

Settings:	10 pm, 20 pm, 50 pm, 100 pm, 200 pm, 500 pm
Accuracy *1,*6:	≤±3% (Res. 50 pm, 1530 to 1610 nm) ≤±2% (Res. 100 pm or more, 1530 to 1610 nm)

Level

Measurement range *2,*3:	-87 to +23 dBm (1250 to 1610 nm) -77 to +23 dBm (950 to 1250, 1610 to 1700 nm) -55 to +23 dBm (600 to 1000 nm)
Accuracy *1,*3:	≤±0.4 dB (1550 nm)
Linearity *1:	≤±0.05 dB (-50 to -10 dBm, 1550 nm)
Scale:	0.1, 0.2, 0.5, 1, 2, 5, 10 dB/DIV and Linear
Repeatability *1,*3,*4:	≤±0.02 dB (1530 to 1610 nm)
Flatness *1:	≤±0.2 dB (1530 to 1610 nm)
Polarization dependency *1,*3:	≤±0.05 dB (1250 to 1610 nm)
Dynamic range *1,*5:	≥50 dB (±100 pm from peak wavelength) ≥60 dB (±200 pm from peak wavelength) ≥67 dB (±400 pm from peak wavelength, High Dynamic Range Mode)

Sweep

Span:	0.2 nm from full span or zero span
Number of samples:	101, 201, 501, 1001, 2001, 5001
Measurement time:	≤500 ms (Span 10 nm, Normal Mode, 1550 nm, average 1 time, 501 samples)

Pulse Light Measurement

Peak holding mode:	Waiting time is set every one measurement point (Gate Time 1 ms to 1 S) and the peak level during this waiting time is displayed Minimum optical pulse width 10 nSec (30 μSec or longer recommended) Optical pulse frequency; 1 Hz or more
External synchronization:	The timing can be controlled by a SYNC signal at the external input. SYNC signal input level; 74 AC (High; 3.5 V, Low; 1.5 V) Pulse width; 10 ns or more
SyncLo Mode:	Minimum light pulse width measurement during SYNC high level is 10 ns (30 μs or longer recommended)
SyncHi Mode:	Sample timing from the rising or falling edge of the SYNC signal is set (0 to 1000 μs)

Features

Memory feature	
Internal RAM:	Measurement data; at least 15 screens (501 samples) (battery backup)
Internal floppy DISK:	3.5 inch 2 HD 1.44 M, MS-DOS format
Display:	Display 2 stacked screens, upper lower 2 screen split, cursor display
Operations/Analysis:	Auto peak search, Auto peak center, Auto reference level Spectrum width analysis (Threshold, Envelope, RMS, Peak RMS, X nm level) Notch width analysis (X dB width, X nm level) Optical amplifier NF analysis feature (up to 128 wavelengths) WDM signal analysis feature (up to 128 wavelengths, level, SNR) Normalize with zoom feature (LOSS/TRANS) Peak power monitor feature (with trend chart)
Others:	Wave length correction (built-in or external light source), wavelength/level offset correction Label feature

Optical input

Adapting fiber:	9.5/125 μm SM fiber (master grade-A connector recommended)
Reflective attenuation:	≥35 dB
Connector (user replaceable):	FC (Std.), ST, SC (accessories sold separately)

Data In/Out

GPIB:	IEEE488-1978
Printer:	Internal thermal printer
Printer interface:	D-SUB 25 pin ESC/P, ESC/P-R, PCL

Options

Light Source for proofreading with EE-LED output:	Output level *1; ≥-43 dBm/nm (1550 nm)
---	--

Specifications

Operating temperature:	+10 to +40°C, Relative humidity 85% or less (non-condensing)
Storage temperature:	-10 to +50°C, Relative humidity 90% or less (non-condensing)
Power Supply:	AC100-120 V/220-240 V, 50/60 Hz, 200 VA or less
Dimensions:	Approx. 424 (W) x 221 (H) x 500 (D) mm
Mass:	29kg or less

*1) At 23°C ±5°C

*2) At 10 to 30°C

*3) At least 100 pm resolution

*4) At 1 min. repetition rate

*5) At 1523 nm wavelength, resolution 10 pm

*6) Correction by effective bandwidth

Please be sure to read the product manual thoroughly before using the products.
Specifications may change without notification.

ADVANTEST CORPORATION
Shinjuku-NS building, 4-1
Nishi-Shinjuku 2-chome
Shinjuku-ku, Tokyo 163-0880,
Japan
Tel: +81-3-3342-7500
Fax: +81-3-5381-7661
<http://www.advantest.co.jp>

Advantest (Singapore) Pte. Ltd.
438A Alexandra Road,
#8-03/06 Alexandra Technopark
Singapore 119967
Tel: +65-274-3100
Fax: +65-274-4055

Tektronix Inc. (North America)
P. O. Box 500 Howard Vollum
Industrial Park Beaverton,
Oregon 97077-0001 U. S. A.
Tel: +1-800-426-2200
Fax: +1-503-627-4090

Rohde & Schwarz
Engineering and Sales GmbH
(Europe)
Mühlendorfstraße 15
D-81671 München
P.O.B. 80 14 29
D-81614 München
Tel: +49-89-4129-3711
Fax: +49-89-4129-3723